

Combo T-REX 150 DFC INSTRUCTION MANUAL

使用說明書

RH15E01XT

ALIGN



Contents

1	INTRODUCTION 前言
1-4	SAFETY NOTES 安全注意事項
5	T-REX 150 FEATURES T-REX 150 產品特色介紹
5	PACKAGE ILLUSTRATION 包裝說明
6	SAFETY CHECK BEFORE FLYING 飛行前安全檢查重要事項
7-9	PART NAMES AND OPTIONAL PART LIST 各部件名稱與選購備品明細
10-11	SERVO INSTALLATION AND ADJUSTMENT 伺服器組裝與調整
12	CANOPY ASSEMBLY 機罩組裝
12	INSTALLATION FOR BATTERY 電池安裝方式
13	EQUIPMENT ILLUSTRATION 設備建議配置圖示
14	PITCH AND THROTTLE SETTING 主旋翼螺距與油門設定
15-16	TRANSMITTER USAGE AND SETTING INSTRUCTION 遙控器使用與設定說明
17-25	150 MRS FLYBARLESS MANUAL 150 MRS 無平擺翼飛行的使用說明
26	POWER COLLOCATION REFERENCE 原裝動力數據參考表
26-28	150 MRS ESC MANUAL 150 MRS ESC使用說明
29-30	150 MRS FLYBARLESS PREFLIGHT CHECK 飛行前測試程序
31-33	FLIGHT ADJUSTMENT AND SETTING 飛行動作調整與設定
34	150 MRS FLYBARLESS FLIGHT TEST PROCEDURE 飛行測試程序
35	TROUBLESHOOTING 飛行中狀況排除

BTF ALIGN/
BIND TO FLY Futaba S-FHSS



3Axs MEMS I2bit S-FHSS Easy Energy Stable G-TARE BB RoHS

Thank you for buying ALIGN products. The T-REX 150 DFC is the latest technology in Rotary RC models. Please read this manual carefully before assembling and flying the new T-REX 150 DFC helicopter. We recommend that you keep this manual for future reference regarding tuning and maintenance.

承蒙閣下選用亞拓遙控世界系列產品，謹表謝意。
進入遙控世界之前必須告訴您許多相關的知識與注意事項，以確保您能夠在學習的過程中較得心應手。在開始操作之前，請務必詳閱本說明書，相信一定能夠給您帶來相當大的幫助，也請您妥善保管這本說明書，以作為日後參考。

Thank you for buying ALIGN Products. The T-REX 150 DFC Helicopter is designed as an easy to use, full featured Helicopter R/C model capable of all forms of rotary flight. Please read the manual carefully before assembling the model, and follow all precautions and recommendations located within the manual. Be sure to retain the manual for future reference, routine maintenance, and tuning. The T-REX 150 DFC is a new product developed by ALIGN. It features the best design available on the R/C helicopters market to date, providing flying stability for beginners, full aerobatic capability for advanced fliers, and unsurpassed reliability for customer support.

感謝您選購亞拓產品，為了讓您容易方便的使用 T-REX 150 DFC 直昇機，請您詳細的閱讀完本說明書之後再進行組裝以及操作這台直昇機，同時請您妥善的保存這本說明書，作為日後進行調整以及維修的參考。T-REX 150 DFC 是由亞拓自行研發的新產品，不論是需求飛行穩定性的初學者或是追求性能的飛行愛好者，T-REX 150 DFC 將是您最佳的選擇。

WARNING LABEL LEGEND 標誌代表涵義



Do not attempt under any circumstances.
在任何禁止的環境下，請勿嘗試操作。



Mishandling due to failure to follow these instructions may result in damage or injury.
因為疏忽這些操作說明，而使用錯誤可能造成財產損失或嚴重傷害。



Mishandling due to failure to follow these instructions may result in danger.
因為疏忽這些操作說明，而使用錯誤可能造成危險。

IMPORTANT NOTES 重要聲明

R/C helicopters, including the T-REX 150 DFC are not toys. R/C helicopter utilize various high-tech products and technologies to provide superior performance. Improper use of this product can result in serious injury or even death. Please read this manual carefully before using and make sure to be conscious of your own personal safety and the safety of others and your environment when operating all ALIGN products. Manufacturer and seller assume no liability for the operation or the use of this product. This product is intended for use only by adults with experience flying remote control helicopters at a legal flying field. After the sale of this product we cannot maintain any control over its operation or usage.

As the user of this product, you are solely responsible for operating it in a manner that does not endanger yourself and others or result in damage to the product or the property of others.

T-REX 150 DFC 遙控直昇機並非玩具，它是結合了許多高科技產品所設計出來的休閒用品，所以商品的使用不當或不熟悉都可能造成嚴重傷害甚至死亡，使用之前請務必詳讀本說明書，勿輕忽並注意自身安全。注意！任何遙控直昇機的使用，製造商和經銷商是無法對使用者於零件使用的損耗異常或組裝不當所發生之意外負任何責任，本產品是提供給有操作過模型直昇機經驗的成人或有相當技術的人員在旁指導於當地合法遙控飛行場飛行，以確保安全無虞下操作使用，產品售出後本公司將不負任何操作和使用控制上的任何性能與安全責任。

作為本產品的使用者，您，是唯一對於您自己操作的環境及行為負全部的責任之人。

We recommend that you obtain the assistance of an experienced pilot before attempting to fly our products for the first time. A local expert is the best way to properly assemble, setup, and fly your model for the first time. The T-REX 150 DFC requires a certain degree of skill to operate, and is a consumer item. Any damage or dissatisfaction as a result of accidents or modifications are not covered by any warranty and cannot be returned for repair or replacement. Please contact our distributors for free technical consultation and parts at discounted rates when you experience problems during operation or maintenance. As Align Corporation Limited has no control over use, setup, final assembly, modification or misuse, no liability shall be assumed nor accepted for any resulting damage or injury. By the act of use, setup or assembly, the user accepts all resulting liability.

模型商品屬於需高操作技術且為消耗性之商品，如經拆裝使用後，會造成不等情況零件損耗，任何使用情況所造成商品不良或不滿意，將無法於保固條件內更換新品或退貨，如遇有使用操作維修問題，本公司全部分公司或代理商將提供技術指導、特價零件供應服務。對使用者的不當使用、設定、組裝、修改、或操作不良所造成的破損或傷害，本公司無法控制及負責。任何使用、設定、組裝、修改、或操作不良所造成的破損、意外或傷害，使用者應承擔全部責任。



· Fly only in safe areas, away from other people. Do not operate R/C aircraft within the vicinity of homes or crowds of people. R/C aircraft are prone to accidents, failures, and crashes due to a variety of reasons including, lack of maintenance, pilot error, and radio interference. Pilots are responsible for their actions and damage or injury occurring during the operation or as a result of R/C aircraft models.

· Prior to every flight, carefully check rotorhead spindle shaft screws and tail blade grip screws, linkage balls and screws, ensure they are firmly secured.

· 遙控模型飛機、直昇機屬高危險性商品，飛行時務必遠離人群，為組裝不當或機件損壞、電子控制設備不良，以及操控上的不熟悉，都有可能導致飛行失控損傷等不可預期的意外，請飛行者務必注意飛行安全，並需了解自負疏忽所造成任何意外之責任。

· 每過飛行前須仔細檢查：主旋翼天座橫軸螺絲、尾旋翼天座螺絲，以及機身各部位球頭、螺絲，確實上膠鎖緊才能升空飛行。



LOCATE AN APPROPRIATE LOCATION 遠離障礙物及人群

R/C helicopters fly at high speed, thus posing a certain degree of potential danger. Choose a legal flying field consisting of flat, smooth ground without obstacles. Do not fly near buildings, high voltage cables, or trees to ensure the safety of yourself, others and your model. For the first practice, please choose a legal flying field.

Do not fly your model in inclement weather, such as rain, wind, snow or darkness.

直昇機飛行時具有一定的速度，相對的也落在高危險性，場地的選擇也相對的重要，請需遵守當地法規到合法遙控飛行場地飛行。務必選擇在空曠合法專屬飛行場地，並必須注意周圍有沒有有人、高樓、建築物、高壓電線、樹木等等，避免操控的不當造成自己與他人財產的損壞。

請勿在下雨、打雷等惡劣天氣下操作，以確保本身及機體的安全。



NOTE ON LITHIUM POLYMER BATTERIES 鋰聚電池注意事項

Lithium Polymer batteries are significantly more volatile than alkaline or Ni-Cd / Ni-MH batteries used in RC applications. All manufacturer's instructions and warnings must be followed closely. Mishandling of Li-Po batteries can result in fire. Always follow the manufacturer's instructions when disposing of Lithium Polymer batteries.

鋰聚電池跟一般在RC使用的鹼性電池、鎳鎘電池、鎳氫電池比較起來是相對危險的，請嚴格遵守鋰聚電池說明書之使用注意事項。不當使用鋰聚電池，可能造成火災及傷及生命財產安全，切勿大意！



PREVENT MOISTURE 遠離潮濕環境

R/C models are composed of many precision electrical components. It is critical to keep the model and associated equipment away from moisture and other contaminants. The introduction or exposure to water or moisture in any form can cause the model to malfunction resulting in loss of use, or a crash. Do not operate or expose to rain or moisture.

直昇機內部也是由許多精密的電子零件組成，所以必須絕對的防止潮濕或水氣，避免在浴室或雨天時使用，防止水氣進入機身內部而導致機件及電子零件故障而引發不可預期的意外！



PROPER OPERATION 勿不當使用本產品

Please use the replacement of parts on the manual to ensure the safety of instructors. This product is for R/C model, so do not use for other purpose.

請勿自行改裝加工，任何的升級改裝或維修，請使用亞拓產品目錄中的零件，以確保結構的安全。

請確認於產品限界內操作，請勿過載使用，並勿用於安全、法令外其它非法用途。



OBTAIN THE ASSISTANCE OF AN EXPERIENCED PILOT 避免獨自操控

Due to the certain learning curve when operating RC helicopters for the first time, avoid attempts by yourself. The guidance provided by an experienced pilot will be invaluable for the assembly, tuning, trimming, and actual first flight or unforeseen danger may happen. (Recommend you to practice with computer-based flight simulator).

遙控直昇機操控技巧在學習初期有著一定的難度，要盡量避免獨自操作飛行，需有經驗的人士在旁指導，才可以操控飛行，否則將可能造成不可預期的意外發生。(勸練電腦模擬器及老手指導是入門必要的選擇)



SAFE OPERATION 安全操作

Operate this unit within your ability. Do not fly under tired condition and improper operation may cause in danger. Never take your eyes off the model or leave it unattended while it is turned on. Immediately turn off the model and transmitter when you have landed the model.

請於自己能力內及需要一定技術範圍內操作遙控直昇機，過於疲勞、精神不佳或不善操作，意外發生風險將會提高。不可在視線範圍外進行，降落後也請馬上關掉直昇機和遙控器電源。





ALWAYS BE AWARE OF THE ROTATING BLADES 遠離運轉中零件

During the operation of the helicopter, the main rotor and tail rotor will be spinning at a high rate of speed. The blades are capable of inflicting serious bodily injury and damage to the environment. Be conscious of your actions, and careful to keep your face, eyes, hands, and loose clothing away from the blades. Always fly the model a safe distance from yourself and others, as well as surrounding objects.

直昇機主旋翼與尾旋翼運轉時會以高轉速進行。在高轉速下的旋翼會造成自己與他人在身體上或環境上的嚴重損傷。請勿觸摸運轉中的主旋翼與尾旋翼，並保持安全距離以避免造成危險及損壞。



KEEP AWAY FROM HEAT 遠離熱源

R/C models are made of various forms of plastic. Plastic is very susceptible to damage or deformation due to extreme heat and cold climate. Make sure not to store the model near any source of heat such as an oven, or heater. It is best to store the model indoors, in a climate-controlled, room temperature environment.

遙控飛機、直昇機多半是以 PA 纖維或聚乙烯、電子商品為主要材質，因此要盡量遠離熱源、日曬，以避免因高溫而變形甚至熔毀損壞的可能。



SAFETY ON THE USE OF DRY CELL BATTERIES 乾電池使用安全

The AA carbon-zinc batteries are one time use, they should not be charged for repetitive use. Please read and follow the guidelines below prior to use. The manufacturer cannot be held liable for accidents and damages as result of improper usage.

- These are one time use battery, and should not be recharged.
- Ensure proper polarity and installation method during use.
- Do not mix battery of different age or different model. Doing so may affect battery life, and even cause fire danger.
- If the product is not used for long period of time, please remove the batteries to prevent damaged caused by battery leaks. Do not use batteries which exhibits symptoms of leaks.
- Please follow local law and ordinances when disposing used batteries. Do not dispose them improperly.

3號(AA)碳鋅電池，不可重複充電使用。使用碳鋅電池前請務必詳讀並遵照下列事項，本公司將不對任何不當使用所造成的損害及意外負責。

- 碳鋅電池為一次性電池，嚴禁重複充電使用。
- 安裝使用時，請確認電池正負極位置及安裝方式。
- 嚴禁新舊或不同型號電池混用，以免影響電池使用壽命，甚至造成電池起火燃燒的危險。
- 產品長時間不使用時，請取出電池，以免造成電池電力流失或電池漏液而損壞主機。若電池已經有漏液情況，請勿再繼續使用。
- 廢棄電池，請依照該使用國家或地區的廢棄物清理法令回收，切勿任意丟棄以免污染環境。

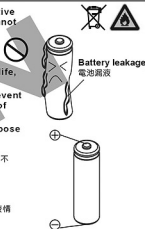

SAFETY ON THE USE OF LITHIUM POLYMER (LIPO) BATTERIES 鋰聚電池使用安全

Lithium batteries have higher degree of risk when compared to other batteries. Please read and follow the guidelines below prior to use. The manufacturer cannot be held liable for accidents and damages as result of improper usage.

- Due to the certain learning curve when operating RC helicopters for the first time, avoid attempts by yourself. The guidance provided by an experienced pilot will be invaluable for the assembly, tuning, trimming, and actual first flight or unforeseen danger may happen. (Recommend you to practice with computer-based flight simulator.)
- Avoid over charging / discharging Li-Po batteries. Doing so may cause internal damages and affect the battery's discharge performance.
- Avoid continuous use under high temperature environment, or when battery exhibits high temperature. Doing so may shorten battery life, causing puffing of battery, or even danger of explosion.
- Discharge the batteries to 60-70% of full capacity for long term storage. Too low of voltage may result in over-discharging over time. Therefore, we recommend periodic charge of battery in long term storage, this will reduce chance of over-discharge damage.
- To avoid the danger of explosion and fire, use of third party charger to charge these batteries are prohibited.
- Avoid impact, disassembly, incorrect polarity, and burning of batteries. Avoid shorting of battery terminal by metallic objects. Avoid puncture of battery with sharp material.
- Charging error could result in battery explosion, fire, and other unexpected danger or property loss. Please always charge batteries with equipment in sight, do not leave charger unattended. Should you need to leave the charging area, please remove the battery and abort charging process.
- Should the battery exhibit excessive heat after use, do not charge immediately. Doing so may cause battery to puff, deform, explode, or even start a fire.
- Please follow local law and ordinances when disposing used batteries. Do not dispose them improperly.



鋰電池較其他電池有更高的危險性，使用前請務必遵照下列注意事項，本公司將不對任何不當使用所造成的損害負責。

- 充電時請使用原廠鋰電池充電器，充電電壓8.4V(4.2V/CELL)電流不可高於0.6A，放電時不得低於最低放電壓3V/CELL。
- 避免電池避免過充與過放的情形發生，過充或過放會對電池內部造成損傷並影響電池放電性能。
- 避免在高溫的環境或電池已經產生高溫而繼續使用，這會使電池壽命減短，嚴重者可能會使電池膨脹甚至爆炸的危險。
- 如果長期不用時，請以60%~70%的充電量儲存。電壓過低時，可能因自放電導致過放，因此，存放不使用的鋰電池時，建議定期充電，以防止自放電低於最小工作電壓而老化，避免電池充滿存放，充飽存放常會導致電池的膨脹。
- 嚴禁使用原廠以外的充電器進行充電，以免發生爆炸起火的危險。
- 嚴禁撞擊、拆解、正負極反接、焚燒電池，避免金屬品接觸電池正負極造成短路，並請防止尖銳的物品刺穿電池，以免電池起火。
- 充電時務必在視線範圍內進行，不可在無人看管的情形下充電，以避免因充電異常造成電池爆裂、燃燒甚至引發火災等不可預期的危險及損失。若需離開看管範圍時應將電池取出，停止對電池充電。
- 電池使用後如有發熱情況，嚴禁充電，否則會造成電池膨脹、變型、爆炸甚至起火燃燒，危害生命財產的安全。
- 廢棄電池，請依照該使用國家或地區的廢棄物清理法令回收，切勿任意丟棄以免污染環境。



BALANCE CHARGER SAFETY PRECAUTIONS 充電器使用注意事項



- ALIGN CH-150 battery charger is suitable to 2cell. Please do not dismantle or change it for other purpose.
- If there is any unusual deformation of the surface of battery, please do not charge it anymore. If the battery becomes hot while charging, stop charging and check if the battery is broken.
- Do not let this machine drench to the rain / water or uses under the heavy moisture, in order to avoid the interior short-circuits and accidents.
- For short-circuits battery, the indicating light of the charger will be off, so please stop charging.
- Charging error could result in battery explosion, fire, and other unexpected danger or property loss. Please always charge batteries with equipment in sight, do not leave charger unattended. Should you need to leave the charging area, please remove the battery and abort charging process.

- 亞拓CH-150充電器適用2cell之鋰電池，請勿自行拆卸，改裝或作為其他用途。
- 外觀已膨脹的電池不可再充電使用；損壞的電池於充電過程中會有發熱的情形，應停止對該電池進行充電。
- 勿讓本機淋到雨水或在重濕氣下使用，以免內部發生短路等不可預期的故障及意外。
- 內部短路的電池，當按上充電表時指示燈會熄滅以示警，應停止對該電池進行充電。
- 充電時務必在視線範圍內進行，不可在無人看管的情形下充電，以避免因充電異常造成電池爆裂、燃燒甚至引發火災等不可預期的危險及損失。若需離開看管範圍時應將電池取出，停止對電池充電。



[HEC15001]

Option equipment
另購品



- Do not use the charger at place near heater or expose of sunshine.
- Keep the vent unimpeded.
- While using, put the charger at a stable place and avoid falling down or colliding.
- 避免靠近熱源或電器產品或在陽光直射環境下使用。
- 散熱口需保持暢通不可堵塞，以免影響散熱效果。
- 使用時請放置於平穩的場所並避免掉落或受到外力撞擊。



[HEC15001]

Option equipment
另購品



- The battery being in use may be a little hot. Please do not charge the battery right away. It might cause the battery broken, even an accident.
- Prevent liquid and anything into the device. If so, please unplug the charger and take out the battery and send it to our distributors to repair.
- If there is an unusual temperature increase, swell, or other unusual occurrences, please unplug the battery and AC plug immediately.

- 當電池剛使用過且表面溫度尚未冷卻時，請勿立即充電，否則將造成電池損壞，甚至引發意外。
- 不要讓異物或任何液體進入機體，如有尖細異物或任何液體進入機體時，請儘快將電源及電池拔除，並送至經銷商或本公司處理。
- 當充電過程中發生電池溫度升高、電池膨脹或其他異常情形時，請立即拔除電池與充電器電源插頭。

[HEC15001]

Option equipment
另購品

- T-REX 150 DFC are fully assembled, tuned, and pass flight test before leaving the factory; this included the 150 MRS Flybarless system parameters and electronic speed controller (ESC).
- T-REX 150 DFC features built in ALIGN/Futaba S-FHSS 2.4Ghz system, and support the use of SPEKTRUM DSM2 / DSMX / JR DSM2 satellite receivers. To get the T-REX 150 airborne, all that needed is inputting of parameters listed in manual into your transmitter, and binding of your transmitter, then you are ready to fly.
- ALIGN's smallest and most petite 3D helicopter T-REX 150, carries the same superior pedigree and design concept that originated from the successful T-REX line of helicopters. Featuring strong power, superior flight control stability, and equipped with high end components, far exceeding any other helicopters currently on the market.
- Miniature size, control precision that s the larger helicopters, enables you to enjoy flying inside a confined space. Beginners can even enjoy this with ease by just turning down the speed dial. The innovative breakthrough T-REX 150 will bring you a new dimension of flying enjoyment.
- T-REX 150 DFC 整機全部由原廠組裝調整完成，其中包括 150 MRS 無平衡翼系統所有參數設定。
- 您只要搭配 ALIGN/Futaba S-FHSS 2.4 GHz 系統遙控器或 SPEKTRUM DSM2/DSMX、JR DSM2/DSMJ/DMSS 衛星天線跟遙控器，並完成說明書內遙控器設定及對頻就可以飛行了。
- T-REX 150 DFC 是亞拓最小、最迷你的 3D 直昇機，它傳承優良的血統，所有設計理念源自於 T-REX 系列直昇機的成功經驗。它具有強勁的動力、超穩定的飛行控制與高檔精細的配備，遠遠超越市面上其他機種。
- 迷你的大小，如同大型機子的操控感，讓您在小空間內就可享受飛行的樂趣，即便是剛入門的初學者，只要調低速度控制旋鈕，就可以輕易的掌舵。T-REX 150 DFC 創新的突破，將是帶給您不同飛行樂趣的全新直昇機。



BTF ALIGN/
BIND TO FLY **Futaba S-FHSS**



Compatible to
ALIGN / Futaba S-FHSS
SPEKTRUM DSM2 / DSMX
JR DSM2 / DSMJ / DMSS
System

3Axis MEMS I2bit S-FHSS Easy Energy Stable G-TRIP 6A RoHS

4.PACKAGE ILLUSTRATION

包裝說明

ALIGN

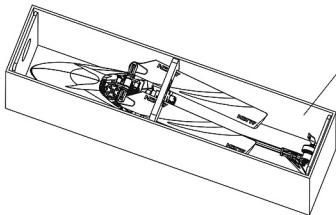

- T-REX 150 DFC Kit x 1set
- T-REX 150 DFC Kit x 1
- 7.4V 250mAh Li-Po Battery x 1
- 7.4V 250mAh Li-Po 電池 x1
- Main Blades (Beginner)x1set
- 主旋翼 (一般) x 1
- Main Blades (Advance) x 1set
- 主旋翼 (3D) x 1
- Main Blade Decal
- 主旋翼貼標
- Binging Plug
- 對頻金屬
- Remote Extension
- 衛星訊號線
- Plastic flat screwdriver
- 塑膠一字起子
- Spare Parts Pack
- 備件包 x1







CAREFULLY INSPECT BEFORE REAL FLIGHT 請嚴格執行飛行前檢查義務

- Please read the manual and RADIO CONTROL SYSTEM instruction manual before operating. Make sure you understand the basic flight knowledge and other important notes. Also always be conscious of your own personal safety with correct learning process.
- Before flight, please check if the batteries of transmitter and receiver are enough for the flight.
- Before turn on the transmitter, please check if the throttle stick is in the lowest position. IDLE switch is OFF. If they are not, the screen of the transmitter will appear warning label with warning beeps until IDLE switch is OFF and throttle stick is in the lowest position.
- When turn off the unit, please follow the power on/off procedure. Power ON- Please turn on the transmitter first, and then turn on receiver. Power OFF- Please turn off the receiver first and then turn off the transmitter. Improper procedure may cause out of control, so please to have this correct habit.
- Before operation, check every movement is smooth and directions are correct. Carefully inspect servos for interference and broken gear.
- Check for missing or loose screws and nuts. See if there is any cracked and incomplete assembly of parts. Carefully check main rotor blades and rotor holders. Broken and premature failures of parts possibly cause resulting in a dangerous situation.
- Check all ball links to avoid excess play and replace as needed. Failure to do so will result in poor flight stability.
- Check the battery and power plug are fastened. Vibration and violent flight may cause the plug loose and result out of control. When IDLE UP throttle curve function is enabled, please be careful and avoid IDLE-UP switch and caused the risk of unexpectedly speed up of the main blades.
- 在開始操作前，請務必詳閱本說明書以及遙控器說明書，了解基本飛行知識與注意事項後再進行實際操作，以確保飛行安全與正確學習過程。
- 每次飛行前請確定您發射機與接收機電池的電量是在足夠飛行的狀態。
- 開機前確認油門搖桿是否於最低點，熄火降開關，定速開關(IDLE)是否於關閉位置；當以上開關未於關閉位置與最低點位置，遙控器開機螢幕會出現警告指示與發出警告聲音，直到開關檢回關閉位置與油門搖桿放回最低點位置。
- 開機時必須遵守電源開關機的程序，開機時應先開啟發射機後，再開接收機電源；關機時應先關閉接收機後，再開關閉發射機電源。不正確的開關程序可能會造成失控的現象，影響自身與他人的安全。請養成正確的操作。
- 開機請先確定直昇機的各個動作是否順暢，及方向是否正確，並檢查伺服器的動作是否有干涉或崩齒的情形，使用故障的伺服器將導致不可預期的危險。
- 飛行前確認沒有缺少或鬆動的螺絲與螺帽，確認沒有組裝不完整或損壞的零件，仔細檢查主旋翼是否有損壞，特別是接近主旋翼夾座的部位。損壞或組裝不完整的零件不僅影響飛行，更會造成不可預期的危險。注意對損耗、有裂損零件更新及定期保養檢查的重要性。
- 檢查所有的連桿頭是否有鬆脫的情形，過鬆的連桿頭應先更新，否則將造成直昇機無法操控的危險。
- 確認電池及電源接頭是否固定牢靠，飛行中的震動或激烈的飛行，可能造成電源接頭鬆脫而造成失控的危險。當遙控器有設置特技飛行模式時，要小心避免不經意的切換到IDLE-UP開關，導致主旋翼突然急劇加速暴衝產生的危險性。

STANDARD EQUIPMENT 標準配備

 <p>T-REX 150 DFC</p>		 <p>7.4V 250mAh Li-Po Battery 7.4V 250mAh Li-Po 電池</p>	 <p>Main Blades x 1set (Beginner) 主旋翼 x 1(一般)</p>	 <p>Main Blades x 1set (Advance) 主旋翼 x 1(3D)</p>
 <p>Main Blade Decal 主旋翼貼標</p>	 <p>Binding Plug 對頻金插</p>	 <p>Remote Extension 衛星訊號線</p>	 <p>Spare Parts Pack 備件包</p>	 <p>Plastic Flat Screwdriver 塑膠一字起子</p>

RADIO TRANSMITTER AND ELECTRONIC EQUIPMENT REQUIRED FOR ASSEMBLY 自備遙控及電子設備

 <p>Compatible to ALIGN / Futaba S-FHSS 2.4 Ghz 遙控器</p>	<p>or 或</p>  <p>SPEKTRUM DSM2 / DSMX JR DSM2 / DSMJ / DMSS System 2.4 Ghz 遙控器</p>	 <p>DMSS</p> <p>or 或</p>  <p>DSM2 / DSMJ</p> <p>or 或</p>  <p>DSMX</p> <p>ALIGN [HER15001]</p> <p>DSM2 / DSMJ / DMSS / DSMX Remote Receiver 衛星天線</p>	 <p>[HEC15001]</p> <p>Lithium Battery Charger 鋰電分壓充電器 2S 500mA</p>
---	--	--	---

6. PART NAMES AND OPTIONAL PART LIST 各部件名稱與選購備品明細 **ALIGN**



More parts information and specification please refer to Parts Quick Finder at ALIGN Cart.
<http://shop.align.com.tw/partfinder.php>
 更多相關零件、規格，請參閱ALIGN Cart。



Apply a little amount of T43 thread lock when fixing a metal part.
 螺絲鎖對於金屬件請使用適量T43(螺絲鎖)



WARNING
警告

1. Prior to every flight, carefully check rotorhead spindle shaft screws, linkage balls and screws, ensure they are firmly secured.
2. Do not over-tighten main blade bolts. The blades must be able to swing freely. Over-tightening will prevent the blades from straightening out, resulting in vibrations.

1. 每趟飛行前須仔細檢查，主旋翼夾座轉軸螺絲，以及機身各部位球頭、螺絲，確實上膠鎖緊才能升空飛行。
 2. 主旋翼固定螺絲不可鎖過緊，要保持旋翼能順暢收折，過緊時會造成旋翼無法用直而產生機體震動。

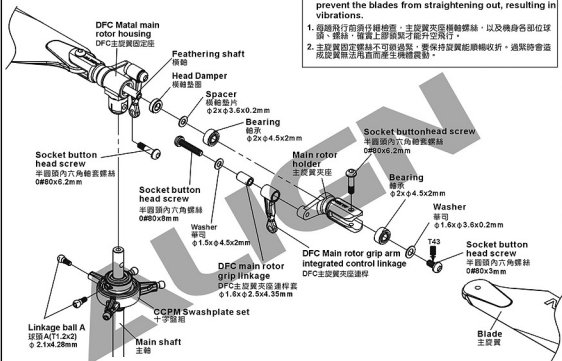

EACH LINKAGE ROD ILLUSTRATION 各連桿示意圖

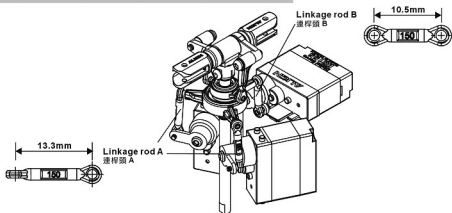



Apply a little amount of T43 thread lock when fixing a metal part.
螺絲鎖附於金屬件請使用適量T43(螺絲膠)



CAUTION
注意

Already assembled by Factory. Before flying, please check if the screws are fixed with glue.

原裝組裝完成品，每一次飛行前請先確認螺絲是否已上膠不會鬆動。

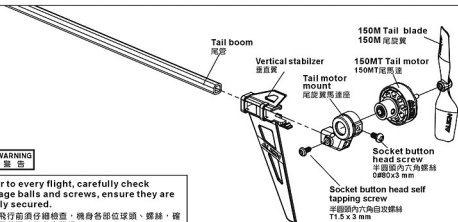
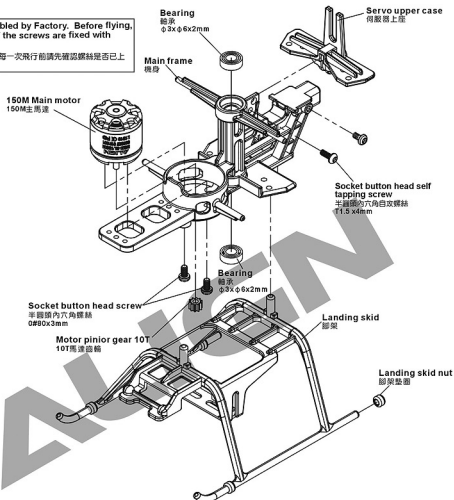

WARNING
警告

Prior to every flight, carefully check linkage balls and screws, ensure they are firmly secured.

每趟飛行前須仔細檢查，機身各部位球頭、螺絲，確實上膠鎖緊才能升空飛行。

Stagger the plugs to pass through tail boom

馬達線插頭以互相前後錯開方式穿過尾管



Please leave sufficient slack on the tail motor wires; excessive tension may cause breakage.

尾馬達線請保持適當鬆緊度，過度拉緊會造成電馬達斷線。

Stagger the motor wires and insert heat shrink tubing into plugs.

馬達線插頭先互相前後錯開，再將熱縮套管往前置入插頭。

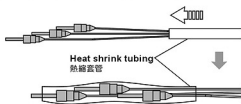

Then pass through tailboom.

接著將套管穿過機身。

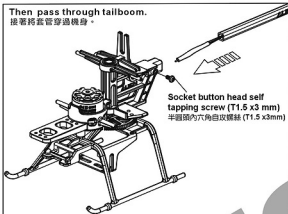

Insert tail motor into motor wire socket through the large hole opening.

將尾馬達線頭裝入馬達線接頭，從大孔端裝入

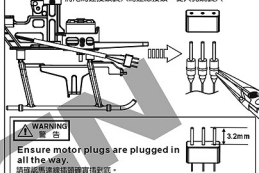

WARNING 警告

Ensure motor plugs are plugged in all the way.

請確認馬達線插頭確實插到底。

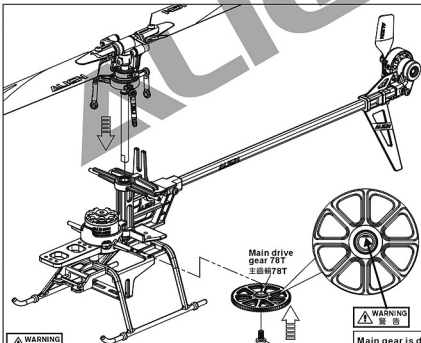

WARNING 警告

WARNING 警告

Prior to every flight, carefully check linkage balls and screws, ensure they are firmly secured.

每趟飛行前須仔細檢查，機身各部位球頭、螺絲，確實上緊鎖緊才能升空飛行。

Main gear is designed to embed into main shaft. When pressing main gear onto main shaft, match the flat spot on the main shaft and press all the way in to ensure it is seated all the way in.

主動齒固定為嵌入設計，當主動齒壓入主動軸時，請對準缺口至定位並確認主動軸上下無虛位。

SERVO SETTING AND ADJUSTMENT 伺服器設定與調整



1. Servo can only be installed in this orientation when T-REX 150 is used: with head point forward, right forward is aileron, left forward is pitch, mid-rear is elevator.
Aileron and elevator cannot be interchanged, otherwise helicopter will not function correctly.
 2. Swashplate type setting on the transmitter should be set to H1 traditional swashplate type. If swashplate movement is incorrect after assembly per instruction, please double check for correct connection. JR/Spektrum transmitter should be set to 1 Servo Normal swashplate type.
1. T-REX 150 伺服器的安裝方式只有一種。當機頭朝前時，右前為副翼；左前為螺距；右後為升降。副翼、螺距不可裝錯。如果沒依照圖示連結，直昇機動作會不正確。
 2. 遙控器十字盤設定，必須選擇 H1 傳統十字盤模式。依照圖示安裝完畢，如果十字盤動作不正確，請檢查伺服器接線是否正確。JR/Spektrum 遙控器為 1 Servo Normal 十字盤模式。

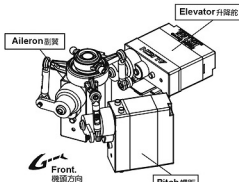

Channel layouts of each radio brands 各廠牌遙控器頻道配置

	CH1	CH2	CH3	CH4	CH5	CH6
Futaba	AIL 副翼	ELE 升降舵	THR 油門	RUD 尾舵	GYRO 感應	PIT 螺距
JR/SPEKTRUM	THR 油門	AIL 副翼	ELE 升降舵	RUD 尾舵	GYRO 感應	PIT 螺距

- Socket button head self tapping screw
半圓頭內六角白攻螺絲 (T1.5x3mm) x 3
- Linkage ball A
球頭 A (T1.2x2) (φ 2.1x4.28mm) x 3

- DS155 Digital Servo / DS155 伺服器:
1. 1520 μs standard band / 1520 μs 寬頻系統
 2. Stall torque / 輸出扭力: 0.8kg.cm (5V)
 3. Motion speed / 動作速度: 0.06sec/60° (5V)
 4. Dimension / 尺寸: 19.8x 8.4 x 23.3mm
 5. Weight / 重量: 4.3g

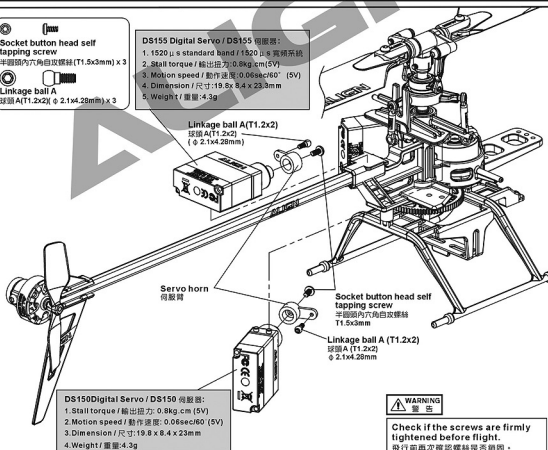

- DS150 Digital Servo / DS150 伺服器:
1. Stall torque / 輸出扭力: 0.8kg.cm (5V)
 2. Motion speed / 動作速度: 0.06sec/60° (5V)
 3. Dimension / 尺寸: 19.8 x 8.4 x 23mm
 4. Weight / 重量: 4.3g



Check if the screws are firmly tightened before flight.
飛行前再次確認螺絲是否鎖緊。

MOTOR WIRE CONNECTED ILLUSTRATION

馬達接線圖

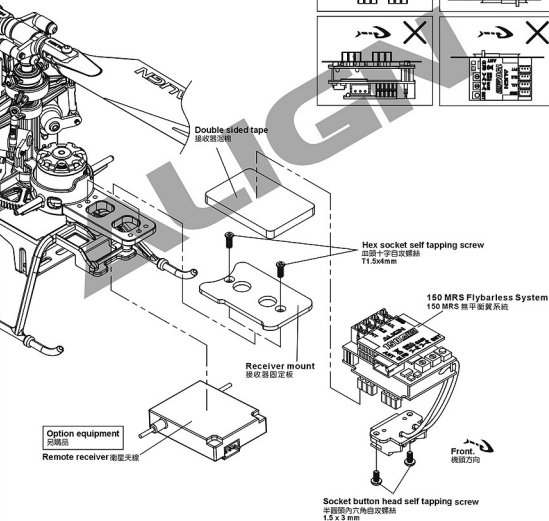
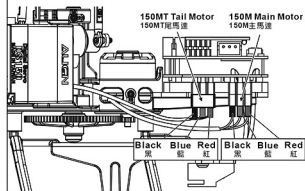

1. 150 MRS can only be installed face down, with antenna point towards the helicopter.
 2. Incorrect installation will cause incorrect compensation of the helicopter swashplate. Flying with incorrect installation will result in crash.
 3. 150 MRS Flybarless system must be mounted using the Align supplied double sided tape; the use of other tapes will affect flight performance.
1. 150 MRS 的安裝方式只有一種，必須為左邊圖示的安裝方式。
2. 安裝錯誤會造成直昇機十字盤修正錯誤，強行飛行會有墜機的危險。
3. 150 MRS 無平衡翼系統，必須使用亞拓提供的專用接收器泡棉來固定，如果使用其他泡棉會影響飛行性能。

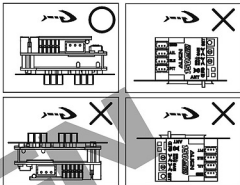

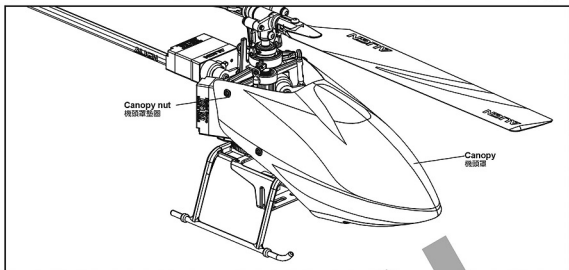

BATTERY INSTALLATION 電池安裝方式

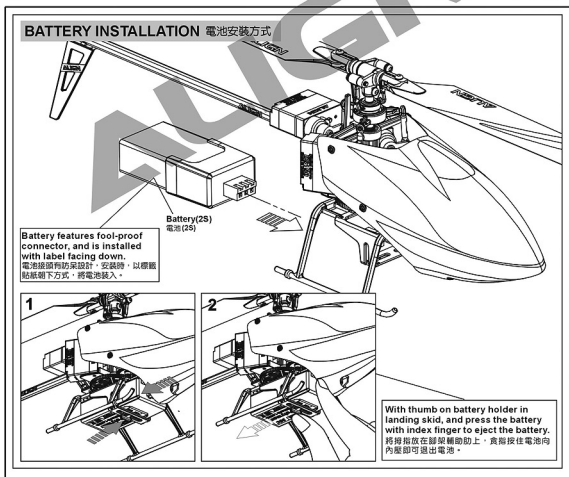

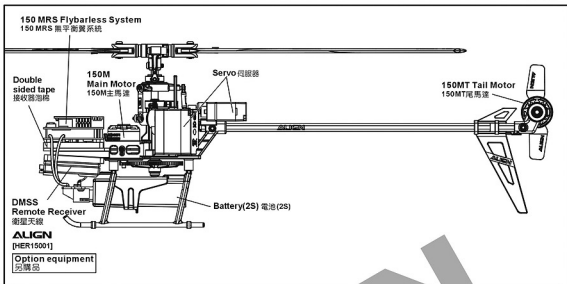

150 MRS WIRING DIAGRAM 150 MRS 接收器接線示意圖

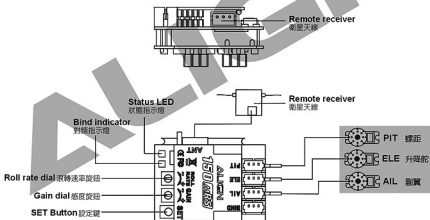

- Gain and roll rate dials are set to 50% as factory default (dial at 12 o'clock position). Should there be any oscillation on aileron or elevator during flight, reduce the gain by turning the dial counter-clockwise approximately 10 degrees at a time.
- Should there be any drift front/rear/left/right during flight, increase the gain by turning the dial clockwise approximately 10 degrees at a time.
- Roll rate dial is used to adjust the roll rate of helicopter's elevator and aileron; turning clockwise will increase roll rate, with faster elevator and aileron response; turning counter-clockwise will decrease roll rate, with slower elevator and aileron response. We recommend novice pilots to fly with lower roll rate.
- 感應與滾轉速度旋鈕，出廠設定值為50%(旋鈕指向12點鐘方向)，飛行時若機體有左右或前後抖動，表示感應偏高，請逆時針調整感應旋鈕，以每次調整約10度方式，調整至適當位置。
- 飛行時若機體有左右或前後漂移時，表示感應偏低，請順時針調高感應旋鈕，以每次10度方式調整至適當位置。
- 滾轉速率旋鈕為調整直昇機升降、副翼滾轉速率，往順時針調大滾轉速率，升降與副翼反應會變快，往逆時針調低滾轉速率，升降與副翼反應會變慢，初飛入門者建議把滾轉速率調低飛行。

GENERAL FLIGHT 一般飛行模式

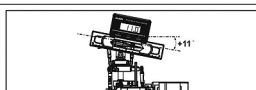

Stick position at high/Throttle 60%/Pitch +11°
搖桿高速/油門60%/Pitch +11°



Stick position at Hovering/Throttle 50-55%/Pitch 0°
搖桿停懸/油門50-55%/Pitch 0°



Stick position at low/Throttle 0%/Pitch -2° ~ 0°
搖桿低速/油門0%/Pitch -2° ~ 0°

3D FLIGHT 3D特技飛行模式



Stick position at high/Throttle 95%/Pitch +11°
搖桿高速/油門95%/Pitch +11°



Stick position at middle/Throttle 85-90%/Pitch 0°
搖桿中速/油門85-90%/Pitch 0°



Stick position at low/Throttle 95%/Pitch -11°
搖桿低速/油門95%/Pitch -11°



1. Pitch range: Approx 26 (± 13) degrees.
2. If the pitch is set too high, it will result in shorter flight duration and poor motor performance.
3. Setting the throttle to provide a higher speed is preferable to increase the pitch too high.

1. 螺距 (Pitch) 總行程約 26 (± 13)。
2. 過大螺距設定，會導致動力與飛行時間降低。
3. 動力提升以較高轉速的設定方式，優於螺距調大的設定。

GENERAL FLIGHT 一般飛行模式

	Throttle 油門	Pitch 螺距
5	60% High speed 60% 高速	+11°
4	55%	
3	50% Hovering 50% 停懸	0°
2	30%	
1	0% Low speed 0% 低速	-2° ~ 0°

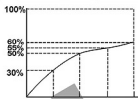

Throttle Curve (Hovering Flight)
停懸模式油門曲線

Pitch and Rotation Speed Pitch與轉速關係

TIP: It is recommended to use a lower pitch setting when using higher RPM/Head speed. This will allow for better power.

注意要項: 如果使用較高轉速的運動動力建議搭配調低 Pitch，將獲得較佳動力效能。

IDLE 1: SPORT FLIGHT

	Throttle 油門	Pitch 螺距
5	90%	+11°
4	86%	
3	84%	0°
2	86%	
1	90%	-11°

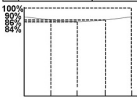

Throttle Curve (Simple Aerobatic Flight)
空中飛行模式油門曲線

IDLE 2: 3D FLIGHT

	Throttle 油門	Pitch 螺距
5	95% High 95% 高	+11°
3	90% Middle 90% 中	0°
1	100% Low 100% 低	-11°

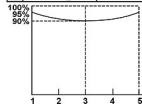

Throttle Curve (3D Flight)
特技飛行模式油門曲線

T-REX 150 DFC complete package was assembled and tuned at the factory, including all parameters in the 150 MRS flybarless system. Just use your ALIGN / Futaba S-FHSS 2.4GHz, SPEKTRUM DSM2 / DSMX or JR DSM2 / DSMJ / DMSS satellite transmitter, complete the following transmitter settings, and bind it to start flying.

T-REX 150 DFC 整機全部是由原廠組裝調整完成，其中包括 150 MRS 無平衡翼系統所有的參數設定。您只要搭配 ALIGN / Futaba S-FHSS 2.4GHz 系統遙控器或 SPEKTRUM DSM2 / DSMX、JR DSM2 / DSMJ / DMSS 衛星天線遙控器，並完成下列遙控器設定以及對頻就可以飛行了。

1. COMPATIBLE TRANSMITTER 適用遙控器

The 150 MRS flybarless system in the T-REX 150 DFC contains a built in ALIGN / Futaba S-FHSS 2.4GHz receiver, and is compatible only with similar ALIGN / Futaba S-FHSS transmitter. In addition, 150 MRS also supports the use of satellite receivers, capable of binding with SPEKTRUM DSM2 / DSMX and JR DSM2 / DSMJ / DMSS radios.

T-REX 150 DFC 所搭配的 150 MRS 無平衡翼系統，內建 ALIGN / Futaba S-FHSS 2.4GHz 接收模組，必須選擇一樣為 ALIGN / Futaba S-FHSS 2.4GHz 系統的遙控器才能對頻使用。另外，150 MRS 也支援衛星天線使用，可以搭配 SPEKTRUM DSM2 / DSMX 與 JR DSM2 / DSMJ / DMSS 衛星天線遙控器對頻使用。

Use ALIGN / Futaba S-FHSS 2.4GHz transmitter.
使用 ALIGN / Futaba S-FHSS 2.4GHz 系統

Using SPEKTRUM DSM2 / DSMX and JR DSM2R / DSMJ / DMSSadio's Satellite Receivers.
使用 SPEKTRUM DSM2 / DSMX、JR DSM2 / DSMJ / DMSS 衛星天線遙控器



2. SELECT H-1 SWASHPLATE TYPE 選擇H-1十字盤類型

150 MRS supports H-1 type swashplate layout. Set the swashplate mode to H-1 in the transmitter's setting. If swashplate type is not setup properly, the control movement will not be correct, making the helicopter unflyable. JR/Spektrum transmitter should be set to 1 Servo Normal swashplate type.

150 MRS 支援的十字盤類型為 H-1 十字盤。選擇要將遙控器的十字盤選項，設定為 H-1 十字盤類型。如果十字盤選擇錯誤，會造成直升機動作不正確無法飛行。JR/Spektrum 遙控器為 1 Servo Normal 十字盤模式。

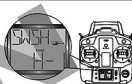

3. TRANSMITTER SETUP PARAMETERS DIAGRAM 遙控器設定表

T-REX 150 DFC already has all 150 MRS parameters configured at the factory. Just follow the diagram below and enter all parameters into the transmitter and bind the radio, the helicopter will be ready to fly. The parameters in diagram below is suitable for beginners and general 3D flying, but can be adjusted to suit personal flying preference.

T-REX 150 DFC 出廠時已提完成 150 MRS 所有設定，只要將下表遙控器各項參數輸入到遙控器中，以及完成對頻動作就可以進行飛行。下表參數適用初學基礎飛行以及一般 3D 飛行使用，您也可以依照個人飛行習慣來調整遙控器參數。

ALIGN / FUTABA S-FHSS SYSTEM ALIGN / FUTABA S-FHSS 系統

	AIL 副翼	ELE 升降	THR 油門	RUD 尾舵	GYRO 感應	PIT 俯正
Servo Reverse 伺服器正反轉	Normal 正向	Normal 正向	Reverse 反向	Normal 正向	Normal 正向	Normal 正向
D / R 雙重比率	▲ 100 % ▼ 100 %	▲ 100 % ▼ 100 %		▲ 100 % ▼ 100 %		
EXP 動作曲線	▲ -30 % ▼ -30 %	▲ -30 % ▼ -30 %		▲ -15 % ▼ -15 %		
End Point Adjust 伺服器行程量	▲ 100 % ▼ 100 %	▲ 100 % ▼ 100 %	▲ 100 % ▼ 100 %	▲ 100 % ▼ 100 %	▲ 100 % ▼ 100 %	▲ 60 % ▼ 60 %

Swash type 十字盤類型

H-1

Gyro gain 尾舵感應	Normal flight / 一般飛行 45 % (AVCS)		3D flight / 3D 飛行 40 % (AVCS)			
	P1	P2	P3	P4	P5	
Normal Throttle Curves 一般飛行油門曲線	0 %	30 %	50 %	55 %	60 %	
Normal Pitch Curves 一般飛行螺距曲線	35 %	42 %	50 %	75 %	100 %	
IDLE-UP Throttle Curves 3D 飛行油門曲線	90 %	86 %	84 %	86 %	90 %	
IDLE-UP Pitch Curves 3D 飛行螺距曲線	0 %	25 %	50 %	75 %	100 %	

SPEKTRUM SYSTEM SPEKTRUM 系統

Servo Reverse 伺服器正反轉	THR 油門	AIL 副翼	ELE 升降	RUD 尾舵	GYRO 感度	PIT 螺距
	Normal 正向	Reverse 反向	Reverse 反向	Reverse 反向	Normal 正向	Reverse 反向
D / R 雙重比率		▲ 100 %	▲ 100 %	▲ 100 %		
		▼ 100 %	▼ 100 %	▼ 100 %		
EXP 動作曲線		▲ 30 %	▲ 30 %	▲ 15 %		
		▼ 30 %	▼ 30 %	▼ 15 %		
End Point Adjust 伺服器行程量	▲ 100 %	▲ 100 %	▲ 100 %	▲ 100 %	▲ 100 %	▲ 70 %
	▼ 100 %	▼ 100 %	▼ 100 %	▼ 100 %	▼ 100 %	▼ 70 %

Swash type 十字盤類型	1 Servo Normal				
Gyro gain 尾舵感度	Normal flight / 一般飛行 55 %			3D flight / 3D飛行 50 %	
Normal Throttle Curves 一般飛行油門曲線	P1	P2	P3	P4	P5
		0 %	30 %	50 %	55 %
Normal Pitch Curves 一般飛行螺距曲線	P1	P2	P3	P4	P5
	35 %	42 %	50 %	75 %	100 %
IDLE-UP Throttle Curves 3D 飛行油門曲線	P1	P2	P3	P4	P5
	90 %	86 %	84 %	86 %	90 %
IDLE-UP Pitch Curves 3D 飛行螺距曲線	P1	P2	P3	P4	P5
	0 %	25 %	50 %	75 %	100 %



These are the standard channel mapping when satellite receivers are used.

(1) THR (2) AIL (3) ELE (4) RUD (5) GAIN (6) PIT
使用衛星天線時，內部通道已指定為：(1) THR (2) AIL (3) ELE (4) RUD (5) GAIN (6) PIT

JR SYSTEM JR 系統

Servo Reverse 伺服器正反轉	THR 油門	AIL 副翼	ELE 升降	RUD 尾舵	GYRO 感度	PIT 螺距
	Normal 正向	Reverse 反向	Reverse 反向	Reverse 反向	Normal 正向	Reverse 反向
D / R 雙重比率		▲ 100 %	▲ 100 %	▲ 100 %		
		▼ 100 %	▼ 100 %	▼ 100 %		
EXP 動作曲線		▲ 30 %	▲ 30 %	▲ 15 %		
		▼ 30 %	▼ 30 %	▼ 15 %		
End Point Adjust 伺服器行程量	▲ 100 %	▲ 100 %	▲ 100 %	▲ 100 %	▲ 100 %	▲ 70 %
	▼ 100 %	▼ 100 %	▼ 100 %	▼ 100 %	▼ 100 %	▼ 70 %

Swash type 十字盤類型	1 Servo Normal				
Gyro gain 尾舵感度	Normal flight / 一般飛行 75 %			3D flight / 3D飛行 70 %	
Normal Throttle Curves 一般飛行油門曲線	P1	P2	P3	P4	P5
		0 %	30 %	50 %	55 %
Normal Pitch Curves 一般飛行螺距曲線	P1	P2	P3	P4	P5
	35 %	42 %	50 %	75 %	100 %
IDLE-UP Throttle Curves 3D 飛行油門曲線	P1	P2	P3	P4	P5
	90 %	86 %	84 %	86 %	90 %
IDLE-UP Pitch Curves 3D 飛行螺距曲線	P1	P2	P3	P4	P5
	0 %	25 %	50 %	75 %	100 %



These are the standard channel mapping when satellite receivers are used.

(1) THR (2) AIL (3) ELE (4) RUD (5) GAIN (6) PIT
使用衛星天線時，內部通道已指定為：(1) THR (2) AIL (3) ELE (4) RUD (5) GAIN (6) PIT

FEATURES 產品特色

- 3Axis** 3-axis gyroscopic flybarless system to simulate the stability of mechanical flybar system, yet at the same time achieving agile 3D performance.
3軸陀螺儀無平衡翼系統，可模擬有平衡翼系統的穩定性，更有靈活的3D性能。
- MEMS** Utilizes MEMS gyro sensors, which feature small footprint, high reliability, and excellent stability.
採用MEMS (Micro Electro Mechanical Systems) 微機電系統技術感測器，具有體積小、可靠性高、穩定性佳的優點。
- 12bit** Sensor with 12 bit ultra high resolution, resulting in highly precise controls.
感測器12位元，超高解析度，控制細膩精準。
- S-FHSS** Supports ALIGN / Futaba S-FHSS 2.4Ghz transmission protocol.
支援ALIGN / Futaba S-FHSS 2.4Ghz 傳輸系統。
- +** Supports SPEKTRUM and JR satellite receivers.
支援SPEKTRUM與JR衛星天線。
- Easy** Simplistic setup process without the need of external devices. Setup is done through 5 steps and 2 sensitivity adjustments.
設定簡單不需額外的介面，只需五個步驟、兩個感度調整即可完成所有設定。
- Energy** Flybarless system dramatically improves 3D power output and efficiency, resulting in reduced fuel or electricity consumption.
無平衡翼系統，可大幅降低3D大動作飛行能量消耗，提供直昇機更大的動力輸出且更加節省燃油或電力。
- Stable** Highly sensitive gyroscopic sensors combined with advanced control detection routine providing higher hovering and aerobatic stability than other flybarless system.
高感度陀螺感測器及先進偵測路設計，可提供比一般平衡翼系統更佳的靜態及動態穩定性。
- T-REX 150** Designed specifically for T-REX 150 DFC, contains optimal flight parameters, no adjustments is needed out of the box to achieve superior flight performance.
針對T-REX 150 DFC設計，內建最佳飛行參數，不需調整即有優異性能表現。
- 6g** Small footprint, light weight, minimalistic and reliable design.
體積小、重量輕，構造簡單可靠，提供操縱者高性能的飛行樂趣。
- RoHS** RoHS certified.
符合RoHS限用規章。

150 MRS FLYBARLESS SETUP INDICATORS 功能設定指示燈說明

FLYBARLESS SYSTEM SETUP MODE 無平衡翼系統設定模式

Flash 1 time: Aileron neutral point	閃爍頻率一次：副翼伺服器中立點設定
Flash 2 times: Elevator neutral point	閃爍頻率二次：升降伺服器中立點設定
Flash 3 times: Pitch neutral point	閃爍頻率三次：俯仰伺服器中立點設定
Flash 4 times: Pitch adjustment	閃爍頻率四次：俯仰角度校正
Steady Green: Rudder compensation	綠燈恆亮：尾舵補償

BIND LED 對頻燈號

STEADY LIT GREEN LED :Radio binding successfully	綠燈恆亮：對頻成功
FLASHING GREEN LED : Radio binding failed	綠燈閃爍：對頻失敗
STEADY LIT RED LED : No signal detected	紅燈恆亮：無發射訊號

ROLL RATE ADJUSTMENT DIAL 滾轉速率調整鈕

Roll rate dial is used to adjust the roll rate of helicopter's elevator and aileron; turning clockwise will increase roll rate, with faster elevator and aileron response; turning counter-clockwise will decrease roll rate, with slower elevator and aileron response. We recommend novice pilots to fly with lower roll rate.
滾轉速率旋鈕為調整直昇機升降、副翼滾轉速率，往順時針調大滾轉速率，升降與副翼反應會變快，往逆時針調低滾轉速率，升降與副翼反應會變慢。初入門者建議把滾轉速率調低飛行。

GAIN ADJUSTMENT DIAL 感度調整旋鈕

Should there be any oscillation on aileron or elevator during flight, reduce the gain by turning the dial counter-clockwise approximately 10 degrees at a time.
Should there be any drift front / rear / left / right during flight, increase the gain by turning the dial clockwise approximately 10 degrees at a time.
飛行的若機體有左右或前後抖動，表示感度偏高，請逆時針調整感度旋鈕，以每次調整約10度方式，調整至適當位置。飛行時若機體有左右或前後飄移時，表示感度偏低，請順時針調高感度旋鈕，以每次10度方式調整至適當位置。

SETUP PRE-CHECK 設定前注意事項

1. During pre-flight check, please ensure 150 MRS is securely mounted, and there are sufficient battery in the transmitter.
2. There is only one way to mount 150 MRS on the helicopter. Do not alter the mounting direction, otherwise incorrect compensation may result in danger of crashing.
3. After 150 MRS has bounded with transmitter, please ensure 150 MRS power indicator is lit correctly, and that swashplate is compensating the correct direction.
4. To ensure proper initialization of 150 MRS, please keep the helicopter stationary during power up, do not move any transmitter sticks.
5. Please ensure the swashplate setting in transmitter is set to H-1 prior to making any setting changes. JR/Spektrum transmitter should be set to 1 Servo Normal swashplate type.
6. While setting neutral position of servos, all steps must be completed before power is turned off, otherwise servos neutral setting will fail. To ensure optimal flight performance, please ensure swashplate is level during swashplate neutral setting.
7. Adjustment of elevator and aileron roll rate must be done with the dials on 150 MRS, do not adjust elevator and aileron travel end points on transmitter. On the other hand, rudder speed is adjusted through rudder end points.
8. To achieve optimal flight performance, pitch and rudder travel can be adjusted on the transmitter, but do not adjust elevator and aileron end points on transmitter.
9. Elevator and Aileron gyro gain must be adjusted through the dials on 150 MRS NG unit. Rudder gyro gain is adjusted through transmitter's GYRO SENS function. To ensure optimal signal reception, 150 MRS antennas should be at least 1/2.
10. 150 MRS is a multi RC protocol system. Power up time for DSM2/DSM-X system is about 5 seconds; Power up time for JR DMSS system is about 5 to 10 seconds; Power up time for ALIGN / Futaba S-FHSS system is about 10 to 12 seconds.

1. 在每次飛行之前，請確認 150 MRS 是否固定良好，並且檢查發射器電力是否足夠。
2. 150 MRS 安裝在直昇機上的方式只有一種，請勿任意更改安裝方向，以免修正錯誤造成危險。
3. 發射器和 150 MRS 完成對頻後，請確認 150 MRS 開機燈號以及十字盤的修正是否正常。
4. 開機時請保持直昇機靜止，且不要動發射器任何搖桿，以免 150 MRS 初始化錯誤。
5. 在進入所有設定之前，請確認發射器的十字盤類型為 H-1 模式。JR/Spektrum 遙控器為 1 Servo Normal 十字盤模式。
6. 在設定陀螺儀中立點位置時，必須把全部步驟完成才可將電源關閉，否則設定值將不被記憶。設定陀螺儀中立點位置時請將十字盤調成水平以獲得最佳飛行性能。
7. 調整升降及副翼的滾轉速率時只能用 150 MRS 上的旋鈕來調整，不可利用發射器上的升降和副翼行程選項來調整。調整尾舵速率時則必須利用發射器上的尾舵行程來調整。
8. 為獲得最佳飛行性能，可以調整發射器上的螺距以及尾舵的行程，但不可調整發射器上的升降和副翼行程。
9. 升降及副翼的陀螺儀感度必須用 150 MRS 上的旋鈕調整，尾舵的陀螺儀感度則利用發射器的 GYRO SENS 選項來調整。
10. 150 MRS 是具備接收功能且兼容多項遙控系統的產品，如果您是使用 DSM2/DSM-X 系統，開機時間約為 5 秒；JR DMSS 系統，開機時間約為 5-10 秒；ALIGN / Futaba S-FHSS 系統，開機時間約為 10-12 秒。

INSTALLATION 150 MRS無平衡翼系統 接線方式

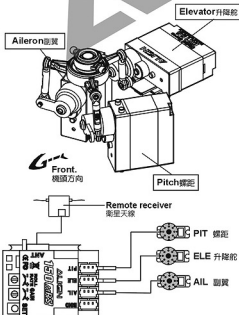

Please ensure the swashplate setting in transmitter is set to H-1 prior to making any setting changes.
請確認發射器的十字盤類型為 H-1 模式。

1. Servo can only be installed in this orientation when T-REX 150 is used: with head point forward, right forward is aileron, left forward is pitch, right-rear is elevator.
Aileron and elevator cannot be interchanged, otherwise helicopter will not function correctly.
2. Swashplate type setting on the transmitter should be set to H1 traditional swashplate type. JR/Spektrum transmitter should be set to 1 Servo Normal swashplate type.
1. T-REX 150 陀螺儀的安裝方式只有一種。當機頭朝前時，右前為副翼；左前為螺距；右後為升降、副翼、螺距不可裝錯。如果沒依照圖示連結，直昇機動作會不正確。
2. 遙控器十字盤類型，必須選擇 H1 十字盤模式。JR/Spektrum 遙控器為 1 Servo Normal 十字盤模式。

Channel layouts of each radio brands 各廠遙控器頻道配置						
	CH1	CH2	CH3	CH4	CH5	CH6
Futaba	AIL 副翼	ELE 升降舵	THR 油門	RUD 尾舵	GYRO 感度	PIT 螺距
JR/SPEKTRUM	THR 油門	AIL 副翼	ELE 升降舵	RUD 尾舵	GYRO 感度	PIT 螺距

TRANSMITTER BINDING 遙控器對頻

The 150 MRS flybarless system in the T-REX 150 DFC contains a built in ALIGN / Futaba S-FHSS 2.4 GHz receiver, support SPEKTRUM DSM2 / DSMX / JR DSM2 / DSMJ / DMSS satellite receiver, and is compatible only with similar S-FHSS's transmitter. Please follow the instruction below to bind your radio to the 150 MRS.

T-REX 150 DFC 機本直昇機，採用最新款 150 MRS 無平衡翼系統，它內建 ALIGN / Futaba S-FHSS 2.4 GHz 系統，具備接收功能一定要搭配 S-FHSS 系統遙控器才能使用或者也可以搭配 SPEKTRUM DSM2 / DSMX 與 JR DSM2 / DSMJ / DMSS 衛星天線遙控器使用，您可以依照下列說明來與 150 MRS 對頻。

ALIGN / FUTABA S-FHSS SYSTEM ALIGN / FUTABA S-FHSS 系統

STEADY LIT GREEN LED :Radio binding successfully
FLASHING GREEN LED :Radio binding failed
STEADY LIT RED LED : No signal detected

綠燈恆亮：對頻成功
綠燈閃爍：對頻失敗
紅燈恆亮：無發射訊號



POWER ON



STEP1. 步驟 1.

Turn on transmitter, connect 150 MRS to power source. If signal is detected, BIND LED will flash green, otherwise it will flash red. If transmitter is turned on, but BIND is still steady red, then power cycle 150 MRS so it will restart transmitter signal search.

打開遙控器，將 150 MRS 接上電源後，若偵測到遙控器訊號，但尚未完成對頻 BIND 燈號會綠燈閃爍。若已開啟發射器，但 BIND 燈為紅燈恆亮，請將 150 MRS 重新切斷電源，重新尋找遙控器訊號。



If the LED status appears steady lit green, it mean the binding is successfully. Please skip Step 2. If the LED status appears flashing green or steady lit red, it means the binding is failed. Please proceed Step 2 for rebinding.

若燈號為綠燈恆亮，代表對頻成功，不須進行步驟 2 重新對頻；
若燈號為綠燈閃爍或紅燈恆亮，代表對頻失敗，則進行步驟 2 重新對頻。

1. Press and hold SET button

長按 SET 鍵不放



POWER ON



STEP2. 步驟 2.

Press and hold SET button, at this time BIND LED will be flashing red, hold the SET button until BIND LED shows steady green, then release SET button to complete binding.

按著 SET 鍵不放，此時 BIND 燈號會紅燈閃爍，直到 BIND 燈號顯示綠燈恆亮後，放開 SET 鍵即完成對頻。

2. LED status changes from flashing red into constant green.

燈號由紅燈閃爍為綠燈恆亮

USING DMSS SATELLITE RECEIVERS 使用 DMSS 衛星天線

BIND & RANGE CHECK

BIND Binding...

NODE:GENERAL
POWER:NORMAL

JR DMSS System Transmitter display
JR DMSS System 遙控器畫面

STEP1. 步驟 1.

Plug the DMSS satellite into ANT port. enable transmitter's "BIND & RANGE CHECK" function to perform frequency binding.

將 DMSS 衛星天線接到 ANT 插槽，開啟遙控器 "BIND & RANGE CHECK" 功能，並執行對頻 (BIND)。

Steady lit blue LED indicates successful frequency binding.
藍燈恆亮表示對頻完成。

DMSS Remote receiver Rj01
衛星天線 Rj01

STEP2. 步驟 2.

Connect helicopter's battery, wait for BIND STATUS LED to light steady green. It indicates successful frequency binding.

將直升機電池接上，等待 BIND 燈與 STATUS 燈綠燈恆亮，表示對頻完成。

Connect the battery
將電池接上



USING DSM2 SATELLITE RECEIVERS 使用DSM2 衛星天線

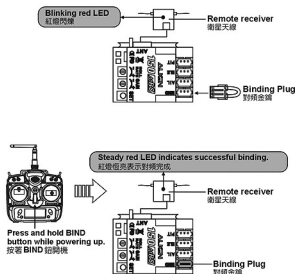

STEP1. 步驟 1.

1. Plug the satellite receiver into ANT port, and the binding plug on BIND channel.
 2. After connecting battery, BIND LED will light flashing red.
1. 將衛星天線接到 ANT 插槽，並且把對頻線接在 BIND 通道。
2. 將電池接上後，此將 BIND 燈為紅燈閃爍，衛星天線為紅燈閃爍。

STEP2. 步驟 2.

1. Press and hold the BIND button on SPEKTRUM / JR transmitter, power on the transmitter, wait for transmitter to display iniding "Binding," then release BIND button.
 2. When satellite receiver LED shows steady lit RED, remove the binding plug from BIND channel.
 3. When STATUS and BIND LEDs turn into steady green, this indicates binding complete and 150 MRS initialized successfully. The system is ready for use.
1. 壓住 SPEKTRUM / JR 發射器的 BIND 按鈕後，打開發射器電源直到發射器面板上顯示 Binding 字樣，在放開 BIND。
2. 等到衛星天線為紅燈恆亮後，將接在 BIND 通道的對頻線移除。
3. 等到 STATUS 和 BIND 燈為綠燈恆亮時，表示對頻以完成且 150 MRS 開機成功，可正常執行功能。

USING DSMX SATELLITE RECEIVERS 使用DSMX 衛星天線

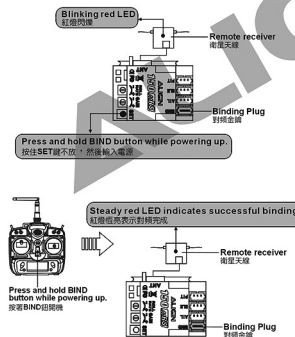

STEP1. 步驟 1.

1. Plug the satellite receiver into ANT port, and the binding plug on BIND channel.
2. Press and hold the SET button on 150 MRS, and feed 5-6V power through RUD or any other channels, BIND LED will turn steady red, while satellite LED flashes red.

1. 先將衛星天線接到 ANT 插槽，並且把對頻線接在 BIND 通道。
2. 按著 150 MRS 的 SET 鍵後，再將電池接上，此將 BIND 燈為紅燈恆亮，衛星天線為紅燈閃爍。

STEP2. 步驟 2.

1. Press and hold the BIND button on SPEKTRUM transmitter, power on the transmitter, wait for transmitter to display "Binding," then release BIND button.
2. When satellite receiver LED shows steady lit RED, remove the binding plug from BIND channel.
3. When STATUS and BIND LEDs turn into steady green, this indicates binding complete and 150 MRS initialized successfully. The system is ready for use.

1. 壓住 SPEKTRUM/JR 發射器的 BIND 按鈕後，打開發射器電源，直到發射器面板上顯示 Binding 字樣，在放開 BIND。
2. 等到衛星天線為紅燈恆亮後，將接在 BIND 通道的對頻線移除。
3. 等到 STATUS 和 BIND 燈為綠燈恆亮時，表示對頻以完成且 150 MRS 開機成功，可正常執行功能。



1. If both SPEKTRUM and Futaba transmitters are powered up (both have previously bound to MRS), and a satellite receiver is connected to 150 MRS, the 150 MRS will select SPEKTRUM system after power up. If no satellite receivers are connected, 150 MRS will select Futaba system.
2. If a satellite receiver is connected to 150 MRS, and only Futaba transmitter is powered up, 150 MRS will select Futaba system after power up. If SPEKTRUM transmitter is powered up afterwards, 150 MRS will not switch over to Spektrum system.
3. On the other hand, if SPEKTRUM transmitter is powered up and 150 MRS has already selected SPEKTRUM system, subsequent power up of Futaba transmitter will not cause 150 MRS to switch over to Futaba system.



1. 如果SPEKTRUM發射器和Futaba發射器都在開啟狀態(先前都已和MRS對頻)，且150 MRS有接衛星天線，若此時將150 MRS開機，150 MRS會選擇SPEKTRUM系統。如果沒有接衛星天線，150 MRS會選擇Futaba系統。
2. 如果150 MRS有接衛星天線，且只有Futaba發射器先開啟，若此時將150 MRS開機，150 MRS會選擇Futaba系統。即便後來再將SPEKTRUM發射器開啟，150 MRS也不會轉到SPEKTRUM系統上。
3. 反之，若SPEKTRUM發射器先開啟，150 MRS選擇SPEKTRUM系統後，即便再將Futaba發射器開啟，150 MRS也不會轉到Futaba系統上。

FAILSAFE(LAST POSITION HOLD) 失控保護(保留最後指令)

When helicopter lost connectivity with your radio under this setting, all channels will hold at the last command position, except throttle channel which goes to a preset position.

1. Push throttle stick to the desired fail safe position.
2. please refer to P.19 & P.20 binding method, and perform radio binding steps.
3. After successful binding, do not power off the 150 MRS, unplug the binding plug and allow 150 MRS to enter initializing process. The last position hold function will be active after the 150 MRS initializes.
4. Test Method: Power off transmitter. The throttle channel should move to preset position, while all other channels should hold in their last position.

在此模式下，若您的直升機與遙控器失連，除油門頻道為預設位置，其餘頻道皆為最後指令位置。

1. 將油門桿放置於您所需要的預設安全位置
2. 依照 19 頁、20 頁的對頻方式，執行與遙控器的對頻動作。
3. 與遙控器完成對頻動作後，不要關閉 150 MRS 電源，先將對頻接頭拔除，150 MRS 會進入開機狀態，待 150 MRS 開機完成後，即完成保留最後指令設定。
4. 測試方法：將遙控器開機，除了油門頻道為預設安全位置外，其餘頻道都為失連前的最後指令位置。

FAILSAFE(PRE-SET POSITION HOLD) 失控保護(回復預設值)

When helicopter lost connectivity with your radio under this setting, all channels will move to the pre-set position.

1. please refer to P.19 & P.20 binding method, and power up the 150 MRS. After the rapid flash of satellite's LEDs, Pull the binding plug off.
2. Power up radio transmitter, and perform radio binding steps. After radio is bound, LED on the satellite antennas will end the rapid flash, following by slower flash.
3. Move the transmitter sticks to the desired failsafe position while the LED is flashing in slower mode.
4. Satellite antenna's LED will lit up after 5 seconds, and 150 MRS goes through initializing process. The failsafe position will be set after the 150 MRS initializes.
5. Test Method: Power off transmitter, and all channels should move to the pre-set failsafe position.

在此模式下，若您的直升機與遙控器失連，所有頻道為預設安全位置。

1. 依照 19 頁、20 頁的對頻方式，先開啟 150 MRS 電源，待衛星天線上 LED 快速閃爍後，將對頻接頭拔除。
2. 開啟遙控器電源，執行與遙控器的對頻動作，對頻完成瞬間衛星天線上 LED 會由快速閃爍狀態變慢，之後再亮起改為慢速閃爍。
3. 在慢速閃爍狀態時，將遙控器上的所有搖桿放置於您所需要的預設安全位置。
4. 5 秒後衛星天線 LED 燈為常亮，150 MRS 進入開機狀態，將 150 MRS 開機完成後，即完成失控保護設定。
5. 測試方法：將遙控器開機，所有頻道為預設安全位置。

150 MRS SETTINGS 150 MRS 設定



In order for the settings to stick, all 5 setting parameters for 150 MRS must be completed followed with a press of SET button, regardless if any changes are made for each settings.

150 MRS 的五項設定，不論有無更改，皆須逐一完成，並按下 SET 鍵退出設定，否則 150 MRS 將不會記憶設定。

150 MRS INITIALIZATION 150 MRS 開機

Connect power, if transmitter binding is successful, BIND LED will light solid green; otherwise it will flash green. At this time, STATUS LED lights green indicates successful power up, steady green means rudder is in heading lock mode; steady red means rudder is in non-heading lock mode. Swashplate will jump up and down 3 times after power up.

接上電源，若遙控器對頻成功後，BIND 燈為綠燈常亮，否則綠燈閃爍。此時 STATUS 燈亮起代表開機成功，綠燈常亮，代表尾舵為鎖定。紅燈常亮，代表尾舵為非鎖定。開機完成時，十字盤會跳三下。

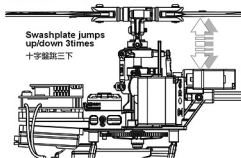

Status LED steady lit
狀態燈常亮



Binding green LED steady lit
對頻綠燈常亮

ENTERING 150 MRS SETUP 進入 150 MRS 設定

Power up transmitter, connect power to 150 MRS. When STATUS and BIND LEDs are light steady green, SET button is used to enter setup mode.

先打開遙控器，將 150 MRS 接上電源後，當 STATUS 和 BIND 燈亮為綠燈常亮時，表示開機完成，此時按 SET 鍵一次即可進入設定。

Flash 1 time: Aileron neutral point
閃爍頻率一次：副翼伺服器中立點設定
Flash 2 times: Elevator neutral point
閃爍頻率二次：升降伺服器中立點設定
Flash 3 times: Pitch neutral point
閃爍頻率三次：螺距伺服器中立點設定
Steady Green: Rudder compensation
綠燈常亮：舵舵補償



Press SET button to enter Setup
按 SET 鍵進入設定

After system initializes, press SET once to enter 150 MRS setup mode. While in setup mode, STATUS LED will flash a number of times indicating the current setting selection. Press SET button to skip to next setting selection. 150 MRS must complete all 5 setting selections before the settings are memorized.

開機完成後，按 SET 鍵一次就會進入 150 MRS 設定。進入設定後 STATUS 燈會以閃爍次數代表所進入的設定選項。按續按 SET 鍵就會跳往下個設定選項，150 MRS 必須完成 5 項設定才會記憶設定內容。

Throttle stick fixed position
油門桿搖桿固定



1. Disconnect motor to ESC to prevent accidental startup during setup.
2. The throttle stick must remain in center position during setup (or Switch HOLD), pitch curve must be at 50% position and remain fixed.
 1. 設定前先拔除馬達線，避免設定中使馬達運轉造成危險。
 2. 設定時油門桿搖桿需置於中間，螺距曲線 50% 輸出的位置 (或切入 HOLD 模式)，不可再移動。

1. AILERON SERVO NEUTRAL POINT SETTING 副翼伺服器中立點設定

Adjust the servo arm to level position
將伺服器搖桿調整至水平

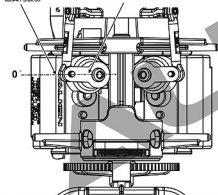

Momentarily press SET button first time, if STATUS LED flashes once continuously and BIND LED is off, this indicates you are in neutral setting mode of servo 1. At this time you can use RUD on transmitter to trim the neutral position of servo 1. After completing this setting it will proceed into next step.

進入 150 MRS 設定的第一層設定為副翼伺服器中立點設定，STATUS 燈為持續閃爍綠燈一次且 BIND 燈亮為低燈。此時可用遙控器舵桿搖桿調整副翼伺服器中立點位置，完成後進入下個步驟。

Move rudder stick to adjust
撥動舵舵調整

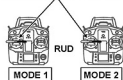

Flash green once
閃爍綠燈一次



2. ELEVATOR SERVO NEUTRAL POINT SETTING 升降伺服器中立點設定

Adjust the servo arm to level position
將伺服器搖桿調整至水平

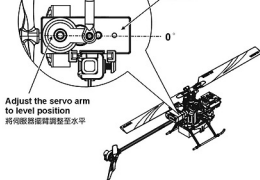

Momentarily press SET button second time, if STATUS LED flashes twice continuously and BIND LED is off, this indicates you are in neutral setting mode of servo 2. At this time you can use RUD on transmitter to trim the neutral position of servo 2. After completing this setting it will proceed into next step.

接著按 SET 鍵一次進入升降伺服器中立點設定，STATUS 燈亮為持續閃爍綠燈二次且 BIND 燈亮為低燈。此時可用遙控器舵桿搖桿調整升降伺服器中立點位置，設定完成後進入下個步驟。

Move rudder stick to adjust
撥動舵舵調整

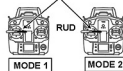

Flash green twice
閃爍綠燈二次



3. PITCH SERVO NEUTRAL POINT SETTING 螺距伺服器中立點設定

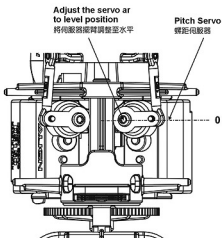

Momentarily press SET button third time, if STATUS LED flashes three times continuously and BIND LED is off, this indicates you are in neutral setting mode of servo 3. At this time you can use RUD on transmitter to trim the neutral position of servo 3. After completing this setting it will proceed into next step.

接著按 SET 鍵一次進入螺距伺服器中立點設定，STATUS 燈號為持續閃爍綠燈三次且 BIND 燈號為熄。此時可用遙控器尾舵桿微調螺距伺服器中立點位置，設定完成後進入下一步驟。

Adjust aileron, elevator, and pitch servos' neutral point so that servo arms and swashplate remain horizontal (with throttle stick at 50% position). How level your swashplate is will directly affect how well the flight characteristic of 150 MRS is.

調整副翼、升降、螺距伺服器中立點，使伺服器擺臂與十字盤皆保持水平位置（此時油門桿須置於 50% 位置），十字盤的水平與否將會直接影響 150 MRS 的飛行表現與穩定性。

Move rudder stick to adjust
移動尾舵調整

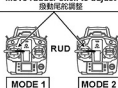

Flash green thrice
閃爍綠燈三次



Adjust the servo ar to level position
將伺服器擺臂調整至水平

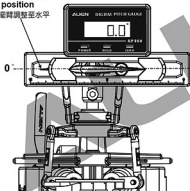

4. ELEVATOR SERVO NEUTRAL POINT SETTING 螺距角度校正

Then press SET once to enter pitch adjustment setting, STATUS LED will flash 4 times continuously while BIND LED is off. Now the rudder stick on the transmitter can be used to adjust main blade pitch to 0 degrees.

接著按 SET 鍵一次進入螺距角度校正設定，STATUS 燈號為持續閃爍綠燈四次且 BIND 燈號為熄。此時可用遙控器尾舵桿調整主翼角度至 0 度位置。

During setup, throttle stick need to be in the middle, 50% output position on pitch curve (or under HOLD condition) 設定時油門桿須置入於中間，螺距曲線 50% 輸出位置（或在 HOLD 模式）。

Move rudder stick to adjust
移動尾舵調整

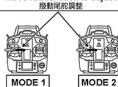

Flashes green 4 times
閃爍綠燈四次



5. ELEVATOR SERVO NEUTRAL POINT SETTING 尾舵補償

Press SET once to enter rudder compensation setting, STATUS LED will be steady lit, while BIND LED will be flashing red. Rudder compensation is turn specifically for the rudder motor holding power of the T-REX 150. All T-REX 150 are factory flight tested, so no adjustment is needed to fly. Adjustment to rudder compensation setting is only needed after motor replacement, or any changes to the helicopter body.

接著按 SET 鍵一次進入尾舵補償設定，STATUS 燈號為常亮，BIND 燈號為紅燈閃爍。尾舵補償是針對 T-REX 150 尾馬達設定強度的補償，T-REX 150 出廠都經過測試與調整，不用更動設定就可以飛行。當有更換馬達或機體變動時，才需要設定尾舵補償。

a. Over-compensation of rudder.

When rudder is over-compensated, helicopter tail will continue to drift clockwise after rudder input. When this occurs, go into rudder compensation setting, use the transmitter's rudder stick to decrease rudder compensation value. The frequency of BIND LED flashing red represents rudder compensation value, factory preset to 3 flashes, maximum 4 flashes, minimum 1 flash.

a. 尾舵補償過大

當尾舵補償過大時，在打尾舵後，真昇機尾巴會持續往順時針方向移動。此時進入尾舵補償設定，使用遙控器尾舵桿降低尾舵補償數值。BIND 燈紅，閃爍頻率為尾舵補償大小，預設值為閃爍 3 次，最大閃爍 4 次，最小閃爍 1 次。



If over-compensated, after stopping rudder input, the tail will continue to rotate clockwise.

補償過大時，打尾舵停止後，尾巴會持續在順時針方向移動。

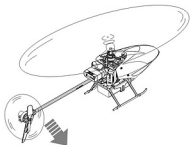

When ruder is under-compensated, helicopter tail will continue to drift counter-clockwise after ruder input. 補償過小時，打尾能停止後，尾巴會持續往逆時針方向移動。

b. Under-compensation of rudder.

When ruder is under-compensated, helicopter tail will continue to drift counter-clockwise after ruder input. When this occurs, go into rudder compensation setting, use the transmitter's rudder stick to increase rudder compensation value. The frequency of BIND LED flashing red represents rudder compensation value, factory preset to 3 flashes, maximum 4 flashes, minimum 1 flash.

b. 尾舵補償過小

當尾舵補償過小時，打尾能後，直升機尾巴會持續往逆時針方向移動。此時進入尾舵補償設定，使用遙控器尾舵的推桿增加尾舵補償數值。BIND 燈紅燈閃爍頻率為尾舵補償大小，預設為閃爍 3 次、最大閃爍 4 次、最小閃爍 1 次。

Move rudder stick to adjust 移動尾舵調整

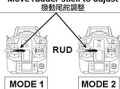

STATUS LED steady lit BIND Flashes red. STATUS 燈常亮 BIND 紅燈閃爍



COLLECTIVE PITCH ADJUSTMENT 集體螺距調整

The collective pitch for 150 MRS must be adjusted in radio's EPA (End Point) function.

150 MRS 集體螺距必須從遙控器 PIT 通道的 EPA (END POINT) 功能中調整。

1. MAX. COLLECTIVE PITCH ANGLE

最大集體螺距角度

Push the throttle stick to the maximum, adjust maximum collective pitch value through radio's EPA function on PIT.

將遙控器油門推桿推至最高，使用 EPA 功能調整 PIT 通道的最大集體螺距角度。

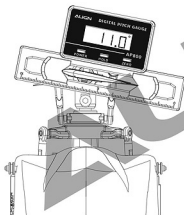

Disconnect motor from ESC prior to setup. 設定前，請先將馬達線拔除。



THRO



2. MIN. COLLECTIVE PITCH ANGLE

最小集體螺距角度

Push the throttle stick to the minimum, adjust minimum collective pitch value through radio's EPA function on PIT.

將遙控器油門推桿推至最低，使用 EPA 功能調整 PIT 通道的最小集體螺距角度。

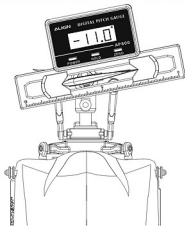





Disconnect motor from ESC prior to setup. 設定前，請先將馬達線拔除。



THRO



150 MRS INDICATOR LED 150 MRS 指示燈說明

STATUS BIND	STATUS constant green STATUS 綠燈恆亮	STATUS constant red STATUS 紅燈恆亮	STATUS off STATUS 不亮
 <p>BIND constant green BIND 綠燈恆亮</p>	<p>Successful initialization and radio bounded, rudder in heading lock mode.</p> <p>完成對頻且開機成功，尾舵為鎖定狀態</p>	<p>Successful initialization and radio bounded, rudder in non-heading lock mode.</p> <p>完成對頻且開機成功，尾舵為非鎖定狀態</p>	<p>—————</p>
 <p>BIND flashing green BIND 綠燈閃爍</p>	<p>Revert back to original transmitter signal that was lost during usage, rudder is in head locking mode, and detected other transition signals.</p> <p>使用過程中失去原本發射器訊號，尾舵為鎖定狀態，且偵測到其它發射訊號</p>	<p>Revert back to original transmitter signal that was lost during usage, rudder is in non-heading lock mode, and detected other transition signals.</p> <p>使用過程中失去原本發射器訊號，尾舵為非鎖定狀態，且偵測到其它發射訊號</p>	<p>150 MRS detects radio signal, but is not bound to the radio.</p> <p>150 MRS 偵測到發射器訊號，但未完成對頻</p>
 <p>BIND constant red BIND 紅燈恆亮</p>	<p>Successful initialization but radio binding failed, rudder in heading lock mode.</p> <p>150 MRS 對頻失敗，但開機成功，尾舵為鎖定</p>	<p>Successful initialization but radio binding failed, rudder in non-heading lock mode.</p> <p>150 MRS 對頻失敗，但開機成功，尾舵為非鎖定</p>	<p>No signal detected from radio, please check if transmitter is powered on.</p> <p>150 MRS 未偵測到發射器訊號，請確認發射器是否開機</p>
 <p>BIND flashing red BIND 紅燈閃爍</p>	<p>Rudder compensation setting procedure</p> <p>尾舵補償設定程序</p>	<p>—————</p>	<p>Signal detected from radio, and set button was pressed for binding.</p> <p>150 MRS 偵測到發射器訊號，且使用者正確 SET 鍵對頻中</p>
 <p>BIND off BIND 不亮</p>	<p>—————</p>	<p>—————</p>	<p>No power connecting to 150 MRS</p> <p>150 MRS 未連接電源</p>

SPECIFICATIONS 產品規格

1. Operating voltage range : 2S Li-Po
2. Operating current consumption : <100mA @ 5V
3. Rotational detection rate : $\pm 500^\circ/\text{sec}$
4. Rudder yaw detection rate : $\pm 500^\circ/\text{sec}$
5. Sensor resolution : 12bit
6. Operating temperature : $-20^\circ\text{C} \sim 65^\circ\text{C}$
7. Operating humidity : 0% ~ 95%
8. Swashplate Support : MODE H-1
9. Receiver Support : ALIGN / Futaba S-FHSS、DSM2 / DSMX / DSMJ / DMSS

1. 操作電壓範圍：2S Li-Po
2. 工作電流：<100mA @ 5V
3. 轉速及前滾角速度範圍： $\pm 500^\circ/\text{sec}$
4. 尾舵角速度範圍： $\pm 500^\circ/\text{sec}$
5. 感測器解析度：12位元(12 BIT)
6. 操作溫度： $-20^\circ\text{C} \sim 65^\circ\text{C}$
7. 操作濕度：0% ~ 95%
8. 支援十字盤類型：H-1 模式
9. 支援發射機類型：ALIGN / Futaba S-FHSS、DSM2 / DSMX / DSMJ / DMSS

RCM-BL150M MAIN MOTOR RCM-BL150M 主馬達

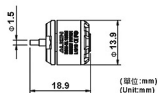
(單位:mm)
(Unit:mm)

SPECIFICATION 尺寸規格

KV	KV值	8200KV(RPM/V)	Input voltage	輸入電壓	2S
Stator Arms	矽鋼片槽數	9	Magnet Poles	磁極槽數	6
Dimension	尺寸	Shaft軸 $\phi 1.5 \times \phi 13.9 \times 18.9$ mm	Weight	重量	Approx. 約6.5g

RCM-BL150MT TAIL MOTOR RCM-BL150MT 尾馬達

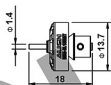
(單位:mm)
(Unit:mm)

SPECIFICATION 尺寸規格

KV	KV值	8000KV(RPM/V)	Input voltage	輸入電壓	2S
Stator Arms	矽鋼片槽數	9	Magnet Poles	磁極槽數	6
Dimension	尺寸	Shaft軸 $\phi 1.4 \times \phi 13.7 \times 18$ mm	Weight	重量	Approx. 約3.3g

15.150 MRS ESC MANUAL 160 MRS ESC使用說明

ALIGN

PRODUCT FEATURES 產品特色

T-REX 150 DFC are assembled, tuned, and passed flight test before leaving the factory; this includes the 150MRS flybarless system and electronic speed controller (ESC). Therefore, the ESC does not need any setup and can be used directly. However, you can still tune the ESC based on the following instructions.

T-REX 150 DFC出廠都是組裝、設定完成且通過試飛的完成機，其中包含150 MRS無平衡翼系統與電子變速器也是設定完成的，所以電子變速器方面並不用重新設定就可以直接使用，當然你也可以參考下列功能說明來設定電子變速器。

1. Dual output system design for main and tail motors. 整合主馬達與尾馬達的雙系統輸出設計。
2. Utilizes high speed, feature rich, but miniature footprint MCU processor. 採用高速、功能強大且體積小的MCU處理器。
3. Includes low voltage, temperature, and loss of throttle signal protection features. 具備低電壓、溫度與油門訊號遺失保護功能。
4. Features numerous adjustable parameter, which can be programmed with simple use of throttle stick on transmitter. 具備多項使用參數調整功能，並可以簡單使用遙控器油門桿來進行設定。

WIRING ILLUSTRATION 接線示意圖

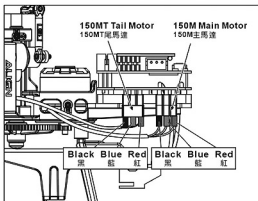

ESC Specs / ESC規格

	Continuous Current 持續	Peak Current 瞬間
Main Motor 主馬達	6A	7A
Tail Motor 尾馬達	3A	3.5A
BEC Output BEC輸出	5V / 2A	5V / 2.5A

1. Persistent maximum current require optimal heat dissipation condition. 持續最大電流需在機體散熱良好情況下。
2. Supported motor types: 2 poles to 18 poles brushless outrunners. 支援馬達型式：2極至18極之內外轉子無碳刷馬達。
3. Maximum rotational speed: 2 poles—240000轉，12極—40000轉。 2極—240000轉，12極—40000轉。
4. Input voltage: 2S Li-Po. 輸入電壓：2S Li-Po。

FUNCTIONS 產品功能

- 1. Brake Option :** 3 settings that include Brake disabled/Soft brake/Hard brake.
 - 2. Electronic Timing Option :** 3 settings that include Low timing/Mid timing/High timing. Generally, 2 pole motors are recommended to use low timing, while 6 or more poles should use Mid timing. High timing gives more power at the expense of efficiency. Always check the current draw after changing the timing in order to prevent overloading of battery.
 - 3. Startup Type -** 3 settings include fast, slow, and super slow startups. Slow startup mode will be slightly faster than super slow startup mode. If motor is stopped while setting is at slow and super slow startup mode, you must wait 4 seconds before slow startup will activate again; if the motor is started within 4 seconds, the motor will start in fast startup mode.
 - 4. Low voltage cutoff type -** Two settings include slow cutoff and immediate cutoff. In immediate cutoff mode, the ESC will cutoff the power immediately after voltage drops below threshold. In slow cutoff mode, the motor speed will be lowered to the normal speed.
 - 5. Throttle Curve Type -** There are 3 throttle curves: CURV1/CURV2/CURV3, to satisfy different pilot's preferences.
 - 6. Li-Po Cell Count -** 4 settings: AUTO/1 CELL/2 CELL/N CELL. Auto is the recommended setting.
 - 7. Low voltage Threshold Setting -** 3 settings: low(5.2V) / mid(5.7V) / high(6.2V). For example, if low voltage threshold is set to low(5.2V), when actual voltage drops to 5.2V, ESC will initiate low voltage protection, causing intermittent cutoffs. The pilot should lower the throttle at this time and prepare for landing.
 - 8. Motor Direction Setting** Two settings: normal and reverse. This setting is used to reverse the motor direction without swapping the motor connectors.
1. 制動設定：三段選擇分別為無制動/軟性制動/急制動
 2. 齒角設定：三段選擇分別為低齒角/中齒角/高齒角 定時機分為2檔以上以及6檔以上無刷齒角馬達，2檔無刷齒角馬達一般適用低齒角，若希望馬達轉速提高，可將齒角設定為中齒角。6檔以上無刷齒角馬達一般適用中齒角，若希望將馬達轉速提高，可將齒角設定為高齒角。然而齒角的調整需要注意電流之變化，避免電池過載，影響電池及高齒角壽命。
 3. 啓動設定：三段選擇分別為快速啟動 / 緩啟動 / 超緩啟動，選擇緩啟動功能在啟動過程中，主旋翼的轉速會緩慢上升，緩啟動時，轉速上升會稍慢一些，而超緩啟動則更慢一些。當設定為緩啟動或超緩啟動，馬達停轉後，必須超過 4 秒鐘之後，才有緩啟動功能，如果在4秒鐘內又啟動馬達，馬達則會快速啟動。
 4. 低電壓保護方式設定：兩段選擇緩慢切斷/立即切斷選擇立即切斷，當電池電壓低於低電壓保護值，電機會立即關閉電源，選擇緩慢切斷，則會將馬達轉速逐漸降到正常轉速的一半。
 5. 油門輸出方式設定：三段選擇CURV 1 / CURV 2 / CURV 3三種不同的油門輸出方式用於滿足不同的使用需求。
 6. 使用鋰電池數設定：四段選擇 自動判別 / 1 CELL / 2 CELL / N CELL，建議使用自動判別設定。
 7. 電池保護電壓設定：三段選擇 低(5.2V) / 中(5.7V) / 高(6.2V) / 假設電池保護電壓設定為低(5.2V)，當電池電壓降到5.2V時，電機會啟動保護，使動力間歇性中斷，此時使用者應將油門收小，準備降落。
 8. 馬達正逆轉設定：兩段選擇 正轉 / 逆轉選項設定，當馬達反向轉動時，可以不需要調線，改變該向設置即可改變馬達轉向。

NORMAL POWER-ON SEQUENCE 正常開機過程

Ensure the throttle stick is at the lowest position.
打開電池，油門桿保持在最低點。



1

Connect power to helicopter, motor emits tones.
直接機上電源，馬達提示音。



Continuous short beeps = detecting transmitter signal
音音持續beep音=偵測發射訊號。



Long single beep = detected lowest throttle signal
長beep音=偵測到最低油門訊號。



Short 2 beeps = detecting voltage, 2S
短beep beep音=偵測電壓 2S。



Startup confirmed = System check OK
啓動確認音=系統檢查OK。

2

THROTTLE RANGE ADJUSTMENT 油門行程校正

Pull the tail motor wires.
將尾馬達線拔除。

Throttle Curve Setting:
油門曲線設定如下:

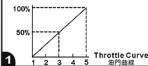

1

Turn on transmitter, move throttle stick to top.
打開遙控器，將油門桿移至於最高點。



2

Connect power to helicopter, motor emits tones.
直接機上電源，馬達提示音。



Continuous short beeps = detecting transmitter signal
音音持續beep音=偵測發射訊號。



Short 2 beeps = throttle highest position Detected
短beep beep音=油門最高點偵測響。

3

Lower the throttle to lowest position within 6 seconds.
在6秒鐘內，將油門桿移至於最低點。



4

Long single beep = detected lowest throttle signal
長beep音=油門最低偵測音響。



Short 2 beeps = detecting battery voltage
短beep beep音=偵測電池電壓。



Power on indicator = system check OK
開機確認音=系統檢查OK。

5

SETUP MODE 設定模式

A. ENTER INTO SETUP MODE 進入設定模式

1 Pull the tail motor wires.
將尾馬達線拔除。

Throttle Curve Setting :
油門曲線設定如下:



2 Turn on transmitter, move throttle stick to top.
打開遙控器，將油門桿移至最頂點。



3 Connect power to helicopter, motor emits tones.
將昇轉機上電，馬達顯示聲。

Continuous short beeps = detecting transmitter signal.
持續短促的蜂鳴聲 = 偵測發射器訊號。

Short 2 beeps = throttle highest position detected.
短促 2 聲蜂鳴聲 = 油門最高點偵測。

After 6 seconds, motor emits tone to indicate entering setup mode.
等待 6 秒後，馬達發出聲音即進入設定。

Special tone = entering ESC
特殊音 = 表示進入 ESC 設定模式。

B. ENTERING SETUP MODE 進入設定選項

After entering setup mode, there are 9 settings with 9 different tones. While going through each of the 9 tones, lower the throttle stick within 3 seconds will enter that specific setting.

進入設定後，共有 9 個選項，並對應 9 種不同提示音，按下順序順項選擇，在要設定的提示音後，3 秒之內將油門桿拉到底，則進入該選項。

(1)	♪ "beep-" 1 short tone = brake (1 短音) = 剎車設定	(2)	♪ "beep-beep-" 2 short tones = electronic timing (2 短音) = 電子角設定	(3)	♪ "beep-beep-beep-" 3 short tones = Startup Type (3 短音) = 啟動設定
(4)	♪ "beep-beep-beep-beep" 4 short tones = low voltage cutoff type (4 短音) = 低電壓保護方式設定	(5)	♪ "beep-" 1 long tones = throttle curve type (1 長音) = 油門輸出方式設定	(6)	♪ "beep-beep-" 1 long 1 short tones = Li-Po cell count (1 長音 1 短音) = 鋰電池節數設定
(7)	♪ "beep-beep-beep-" 1 long 2 short tones = battery protection (1 長音 2 短音) = 電池保護電壓設定	(8)	♪ "beep-beep-beep-beep-" 1 long and 3 short tones = motor direction (1 長音 3 短音) = 馬達正逆轉設定	(9)	♪ "beep-beep-beep-" 3 long tones = exit setup mode (3 長音) = 退出設定

C. SETTING PARAMETERS 各項程式設定參數表

Note: "●" default setting

註: "●" 表示出廠設定值

Item 項目	Tones 顯示音	One beep 一聲	2 beeps (beep-beep) 兩聲	3 beeps (beep-beep-beep) 三聲	4 beeps (beep-beep-beep-beep) 四聲
Brake 剎車設定		● Brake disabled 無煞車	Soft brake 軟性煞車	Hard brake 急煞車	
Electronic Timing 電子角設定		Low-timing 低電子角	Mid-timing 中電子角	● High-timing 高電子角	
Startup Type 啟動設定		Fast startup 快速啟動	Soft Start 緩啟動功能	● Super slow startup 超級緩啟動功能	
Low voltage cutoff type 低電壓保護方式設定		● Slow cutoff 緩慢切斷	Immediate cutoff 立即切斷		
Throttle curve type 油門輸出方式設定		● CURV1	CURV2	CURV3	
Li-po cell count 使用鋰電池節數設定		Auto detect 自動判別	1 CELL	● 2 CELL	N CELL
Battery protection 電池保護電壓設定		5.2V	● 5.7V	6.2V	
Motor direction 馬達正逆轉設定		● Normal 正向	Reverse 逆向		

D. SETUP SEQUENCE 設定流程

1 Follow step a to enter setup mode.
依照步驟 a 進入設定模式。

2 there are 9 settings with 9 different tones.
共有 9 種馬達提示音，對應 9 種設定。

♪ Brake (剎車設定)
♪ Electronic Timing (電子角設定)
♪ Startup Type (啟動設定)
⋮

3 For example, to set the motor timing, push throttle stick to lowest position after hearing
♪ (beep-beep).
假如要設定馬達電子角設定，在
♪ "beep-beep" 提示音後將油門桿拉至最低點。



4 At this time motor will emit timing setup indicator tone.
此時馬達會發出電子角設定的提示音。

♪ Low-timing (低電子角)
♪ Mid-timing (中電子角)
♪ High-timing (高電子角)

5 After hearing the tone for desired timing value, push throttle stick up, motor will emit 5656 tone indicating setting has been set.
在要設定的電子角聲音提示音後，將油門桿桿電壓至最高，此時馬達會發出 5656 顯示設定設定被選擇且保存。



6 Return to the 9 settings indicator tones.
回到 9 種功能設定的提示音。

♪ Startup Type (啟動設定)
♪ Low voltage cutoff type (低電壓保護方式)
⋮



7 Exit setup: after hearing the ninth indicator tones of 3 beeps, please pull the throttle stick to lowest position to exit setup mode.
退出設定：在聽到第九種提示音 3 聲後，將油門桿拉至最低點。

♪ "beep-" 1 long beep = throttle lowest position detected (1 長音) = 油門最低點偵測
♪ "beep-beep-" Short 2 beeps = detecting battery voltage (2 短音) = 偵測電池電壓
Power on indicator = system check OK
開機提示燈 = 系統檢查 OK

STEP1 步驟1

Turn on Transmitter, and then 150 MRS power.
先開啟遙控器電源，再開啟 150 MRS 電源。

STEP2 步驟2

At this time, 150 MRS BIND LED will lit steady green, and STATUS will be lit steady green or steady red.
此時 150 MRS BIND 燈會綠燈恆亮，STATUS 會綠或紅燈恆亮。

STEP3 步驟3

As shown in diagram to the left, the washplate will twitch up and down 3 times after initialization to signal successful startup.

If washplate twitches up and down 3 times with washplate tilted, check for correct servo installation as per instruction.

如左圖示，初始化完成後，十字盤會保持水平平行下小幅跳動三次，表示完成開機程序，如十字盤為傾斜跳動三次，請檢查伺服器是否依照指示安裝。

完成開機前直昇機螺旋槳固定無法動作，如果一直無法完成開機程序，請檢查開機時直昇機是否靜止或訊號線未接妥，確認後重新開機，正常開機後，STATUS 亮綠燈表示尾舵為鎖定模式，亮紅燈為非鎖定模式。

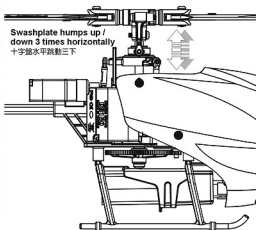

○ Washplate jumps up and down 3 times horizontally represents successful initialization.
十字盤水平跳動三次代表正常開機



✗ Washplate jumps up and down 3 times tilted represents setup error.
十字盤傾斜跳動三次代表伺服器安裝錯誤



Green LED indicates rudder lock mode
Red LED indicates non-rudder lock mode
綠燈為尾舵鎖定模式
紅燈為尾舵非鎖定模式

**STEP4 步驟4**

Tilt the helicopter forward and washplate should tilt back to compensate. If reversed, perform the flybarless initial setup again and adjust the elevator reverse setting.

將直昇機往前傾，陀螺儀應將十字盤向後修正，如果反向，請檢查 150 MRS 是否依照指示安裝。

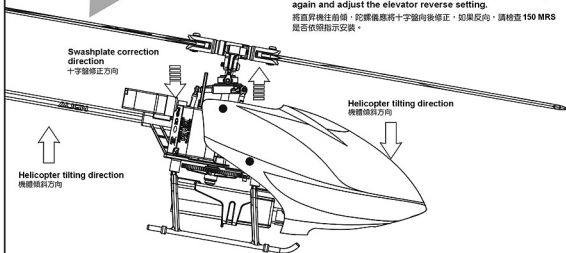

Swashplate correction
direction
十字盤修正方向



Helicopter tilting
direction
機體傾斜方向

STEP5 步驟 5

Tilt the helicopter right, gyro should tilt the swashplate left to compensate. If reversed, please check for the correct installation direction of 150 MRS.

將直昇機往右傾，陀螺儀應將十字盤往左修正，如果反向，請檢查150 MRS是否依照指示安裝。

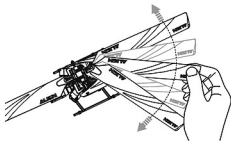

STEP6 步驟 6

Do not over-tighten main blade bolts. The blades must be able to swing freely. Over-tightening will prevent the blades from straightening out, resulting in vibrations.

主旋翼固定螺絲不可鎖過緊，要保待旋翼能順暢收折，過緊時會造成旋翼無法伸直而產生機體震動。

STEP 7-1 步驟 7-1

Hold the helicopter by hand to test rotation, and fly only if confirmed there are no excessive vibration from helicopter. During test, hold the helicopter firmly, away from face/head, and push the throttle up to 50%~60% under normal mode.

將直昇機抓在手上試運轉，確認直昇機無過大震動才可以飛行，試運轉時請將直昇機抓好，並遠離頭部，使用一般模式，油門推到 50%~60% 測試。

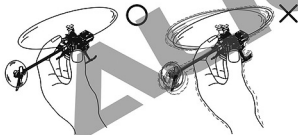

FORBIDDEN
禁止

Do not hold the landing skids when performing power on test for helicopter vibration, to avoid skids apart from helicopter causing unexpected accidents.

嚴禁使用抓腳架方式來測試直昇機震動！避免因為腳架脫落，造成不可預期的意外發生。

STEP 7-2 步驟 7-2

Should there be excessive vibrations, first check if there are any damaged or improperly installed parts (such as bent main and feathering shaft). If vibration persists after all parts are confirmed ok, the main blades can be balanced with the included weight stickers (each sticker around 0.02g)

如果直昇機震動過大，請先確認機體各部位是正常無損壞或安裝不良(例：主、橫軸彎曲)。確認機體正常後，直昇機還是有震動，可以使用隨機附送的主旋翼配重貼紙(單張約0.02g)，來為主旋翼進行配重平衡。

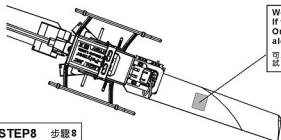

Weight stickers can be applied to the center of the backside. If vibration increases, move the sticker to the other blade. Once vibration is reduced, the sticker can be moved laterally along the blade to further minimize vibrations.

可以貼在旋翼背面的中心位置測試，如果震動加大，則換到另一支旋翼測試，震動減小後可移動貼紙位置讓震動減至最小。



STEP8 步驟 8

Confirm all functions are normal, power cycle the system, and begin flight test after initialization.

確定所有功能正常，重新開機，完成開機程序後進入飛行測試。

[HOT0010]
150 blades balancer
150主旋翼平衡組

PLEASE PRACTICE SIMULATION FLIGHT BEFORE REAL FLYING 飛行前請事先熟練模擬飛行

A safe and effective practice method is to use the transmitter flying on the computer through simulator software sold on the market. Do a simulation flight until you familiarize your fingers with the movements of the rudders, and keep practicing until the fingers move naturally.

1. Place the helicopter in a clear open field (Make sure the power OFF) and the tail of helicopter point to yourself.
2. Practice to operate the throttle stick (as below illustration) and repeat practicing "Throttle high/low", "Aileron left / right", "Rudder left / right", and "Elevator up / down".
3. The simulation flight practice is very important, please keep practicing until the fingers move naturally when you hear operation orders being call out.

在還沒瞭解直昇機各動作的操控方式前，嚴禁實機飛行，請先進行電腦模擬飛行的練習，一種最有效、最安全的練習方式，就是透過市面販售的模擬軟體，以遙控器在電腦上模擬飛行，熟悉各種方向的操控，並不斷的重複，直到手能可熟練的控制各個動作及方向。

1. 將直昇機放在空曠的地方 (確認電源為關閉)，並將直昇機的機尾對準自己。
2. 練習操作遙控器的各搖桿 (各動作的操作方式如下圖)，並反覆練習油門高/低、副翼左/右、升降的前/後及方向舵左/右操作方式。
3. 模擬飛行的練習相當重要，請重複練習直到不需思索，手指能自然隨著喊出的指令移動控制。



Mode 1	Mode 2	Illustration 顯示

FLIGHT ADJUSTMENT AND NOTICE FOR BEGINNERS 初學飛行調整與注意



- ⊙ Check if the screws are firmly tightened.
- ⊙ Check if the transmitter and receivers are fully charged.
- ⊙ 再次確認一螺絲是否鎖固?
- ⊙ 發射器和接收器電池是否足夠。

- When arriving at the flying field.
- 當抵達飛行場。



To avoid unforeseen dangers such as loss of control, ensure successful binding of transmitter has been completed, and check for proper movement of each functions.
 請確認發射機選對模型且對頻完成，各項設定及動作正確，才能避免發生失控等不可預期意外。

STARTING AND STOPPING THE MOTOR 啟動和停止馬達



First check to make sure no one else is operating on the same frequency. Then place the throttle stick at lowest position and turn on the transmitter.

首先確認附近沒有其他相同頻率的使用，然後打開發射器將油門搖桿推到最低點。



Check if the throttle stick is set at the lowest position.
 確認油門搖桿是在最低的位置。

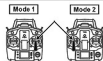

- Check the movement.
- 動作確認



- ON! Step1
- First turn on the transmitter.
- 先開啟發射器

- ⊙ Are the rudders moving according to the controls?
- ⊙ Follow the transmitter's instruction manual to do a range test.
- ⊙ 方向舵是否隨著控制方向移動?
- ⊙ 根據發射器說明書進行距離測試。



- ON! Step2
- Connect to the helicopter power
- 接上直昇機電源



- OFF! Step3
- Reverse the above orders to turn off.
- 關閉電源時請按上述操作動作反執行。

FLIGHT ADJUSTMENT AND NOTICE FOR BEGINNERS 初學飛行調整與注意

During the operation of the helicopter, please stand approximately 2M diagonally behind the helicopter.
 飛行時，請站在直昇機後方 2 公尺。



- ⊙ Make sure that no one or obstructions in the vicinity.
- ⊙ You must first practice hovering for flying safety. This is a basic flight action. (Hovering means keeping the helicopter in mid air in a fixed position)
- ⊙ 確認鄰近地區沒有人和障礙物。
- ⊙ 為了飛行安全，您必須先練習停懸，這是飛行動作的基礎
 (停懸：直昇機滯留空中並保持固定位置)。



STEP 1 THROTTLE CONTROL PRACTICE 油門控制練習

When the helicopter begins to lift-off the ground, slowly reduce the throttle to bring the helicopter back down. Keep practicing this action until you control the throttle smoothly.

當直昇機開始離地時，慢慢降低油門將飛機降下。
持續練習飛機從地面上升和下降直到您覺得油門控制很順。



STEP 2 AILERON AND ELEVATOR CONTROL PRACTICE 副翼和升降控制練習

1. Raise the throttle stick slowly.
2. Move the helicopter in any direction back, forward, left and right, slowly move the aileron and elevator sticks in the opposite direction to fly back to its original position.

1. 慢慢升起油門搖桿。
2. 使直昇機依指示：移動向後/向前/向左/向右，慢慢的反向移動副翼和升降搖桿並將直昇機調回到原來位置。

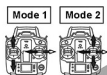

- ⊙ If the nose of the helicopter moves, please lower the throttle stick and land the helicopter. Then move your position diagonally behind the helicopter 5M and continue practicing.
- ⊙ If the helicopter flies too far away from you, please land the helicopter and move your position behind 5M and continue practicing.
- ⊙ 當直昇機機頭偏移時，請降低油門並且降落，然後移動自己的位置到直昇機的正後方5公尺再繼續練習。
- ⊙ 假若直昇機飛離您太遠，請先降落直昇機，並到直昇機後5公尺再繼續練習。

STEP 3 RUDDER CONTROL PRACTICING 方向舵操作練習

1. Slowly raise the throttle stick.
2. Move the nose of the helicopter to right or left, and then slowly move the rudder stick in the opposite direction to fly back to its original position.

1. 慢慢升起油門搖桿。
2. 將直昇機機頭移動左或右，然後慢慢反向移動方向舵搖桿並將直昇機飛回原本位置。

STEP 4

After you are familiar with all actions from Step1 to 3, draw a circle on the ground and practice within the circle to increase your accuracy.

⊙ You can draw a smaller circle when you get more familiar with the actions.

當您覺得 Step1~3 動作熟悉了，在地上畫個圈並在這個圈內的範圍內練習飛行，以增加您操控的準確度。
⊙ 當您更加器操作動作，您可以畫更小的圈圈。



STEP 5 DIRECTION CHANGE AND HOVERING PRACTICE 改變直昇機方向和練習停懸

After you are familiar with Step1 to 4, stand at side of the helicopter and continue practicing Step1 to 4. Then repeat the Step1 to 4 by standing in front of the helicopter.

當您覺得 Step1~4 動作熟悉了，站在面對直昇機側邊並繼續練習 Step1~4 之後，站在直昇機機頭前方重複步驟練習。

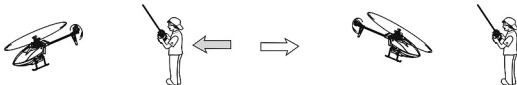

ELEVATOR AND AILERON GAIN ADJUSTMENT 升降及副翼陀螺儀感度調整

Hover the helicopter and observe if there are any left / right or forward / backward fast oscillation. If oscillation exists, turn the gain dial counter-clockwise to reduce the gyro gain.

先將直昇機以懸停飛行，觀察直昇機左右及前後是否有不正常快速抖動現象，如果前後或左右有抖動，請將感度旋鈕逆時鐘調低，以減少陀螺儀修正感度。

SET THE DIAL TO 12 O'CLOCK POSITION AS STARTING POINT 建議初次飛行設於 12 點鐘方向

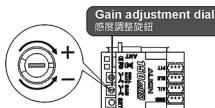

Decrease lock gain sensitivity
調降低感度



Forward/back oscillation · Left/right oscillation
前後晃動 / 左右晃動

FORWARD STRAIGHT LINE FLIGHT 前進直線軌道飛行

After hovering, proceed to fast forward flight. Should there be similar oscillation, please reduce gain. Should the helicopter pitch up or experience slow response during flight, increase gain. Repeat this process until ideal gain value is achieved. Pilot can also adjust the cyclic EXP setting for the preferred stability. After all adjustments are completed, the pilot can enjoy the stability of slow flight and the fast agility from flybarless system.

停懸完後可快速前進飛行，同樣的如果有不正常抖動時，請將感度調小，飛行時如果有機頭向上仰起或反應緩慢現象時，請將感度調大，重複測試將感度調整至最理想值，使用者也可依據個人經驗調整陀螺 EXP 以增加停旋穩定性。完成所有調整後，就可享受 150 MRS 所提供低速飛行的穩定性及高速時的靈活。



Forward Flight
前進飛行

ROLL RATE ADJUSTMENT 滾轉速率調整

Roll rate dial is used to adjust the roll rate of helicopter's elevator and aileron; turning clockwise will increase roll rate, with faster elevator and aileron response; turning counter-clockwise will decrease roll rate, with slower elevator and aileron response. We recommend novice pilots to fly with lower roll rate.

滾轉速率旋鈕調整升降，副翼滾轉速率，往順時針調大滾轉速率，升降與副翼動作反應會變快，往逆時針調低滾轉速率，升降與副翼動作反應會變慢，初級入者建議把滾轉速率調低飛行。

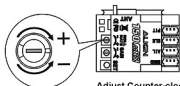

Adjust Counter-clockwise for less sensitive response
逆時針調整，直昇機反應較緩和

	Problem 狀況	Cause 原因	Solution 對策
Blade Tracking 雙槳平衡	Tracking is Off 雙槳	Bent feathering shaft or warped main blades. 橫軸彎曲或主旋翼變型	Replace the feathering shaft or main blades 更換橫軸或主旋翼
Hover 停懸	Head speed too low 主旋翼轉速偏低	Excessive pitch 主旋翼的 PITCH 偏高	Adjust pitch DFC to reduce pitch by 4 to 5 degrees. (Hovering head-speed should be around 5000RPM. 將 PITCH 調低約 +4-5 度 (停懸時主旋翼需為約 5000RPM)
		Hovering throttle curve is too low 停懸點油門曲線過低	Increase throttle curve at hovering point on transmitter (around 65%) 調高停懸點油門曲線 (約 65%)
	Head speed too high 主旋翼轉速偏高	Not enough pitch 主旋翼的 PITCH 偏低	Adjust pitch to increase pitch by 4 to 5 degrees. 將 PITCH 調高約 +4-5 度
		Hovering throttle curve is too high 停懸點油門曲線過高	Decrease throttle curve at hovering point on transmitter (around 65%) 調低停懸點油門曲線 (約 65%)
Rudder Response 尾舵反應	Drifting of tail occurs during hovering, or delay of rudder response when centering rudder stick. 停懸時尾舵向某一邊偏移，或控制方向舵並回復到中立點時，尾翼產生延遲，無法停頓在所控制位置上。	Over or under rudder compensation 尾舵補償過大或過小	Tail drafts counter-clockwise → increase rudder compensation 尾舵往逆時針方向偏移 → 加大尾舵補償 Tail drafts clockwise → decrease rudder compensation 尾舵往順時針方向偏移 → 減小尾舵補償
		Rudder gyro gain too low 尾舵陀螺儀感度偏低	Increase rudder gyro gain 增加尾舵陀螺儀感度
	Tail oscillates (hunting, or wags) at hover or full throttle 停懸或全油門時尾翼左右來回搖擺。	Rudder gyro gain too high 尾舵陀螺儀感度偏高	Reduce rudder gyro gain 降低尾舵陀螺儀感度
Oscillation during flight 飛行抖動	Helicopter oscillates forward/backward/left/right while performing cyclic maneuvers 升降舵或副翼打舵動作時，機體前後左右抖動。 Helicopter front bobbles (nods) during forward flight. 直線飛行時，機頭點頭。	Swashplate gyro gain is slightly too high. 十字盤陀螺儀感度偏高，產生過敏現象。	Turn the gain dial on 150 MRS counter-clockwise, 10 degrees at a time until oscillation is eliminated. 逆時針調整 150 MRS 上的感度調整按鈕，以每次調整約 10 度的方式，調整至適當位置。
		Worn servo, or slack in control links 伺服器老化，控制結構有虛位。	Replace servo, ball link, or linkage balls. 更換伺服器、連桿、球頭。
Drifting during flight 飛行飄移	Pitching up or aileron drift during forward flight 直線飛行機頭上揚或副翼飄移	Swashplate gyro gain is slightly too low 十字盤陀螺儀感度偏低	Turn the gain dial on 150 MRS clockwise, 10 degrees at a time until drifting is eliminated. 順時針調整 150 MRS 上的感度調整按鈕，以每次調整約 10 度的方式，調整至適當位置。
Control Response 動作反應	Slow Forward/Aft/Left/Right input response 前後左右飛行動作反應偏慢	Roll rate too low 滾轉速率偏低	Adjust 150 MRS roll rate dial clockwise. 順時針調整 150 MRS 滾轉速率按鈕
	Sensitive Forward/Aft/Left/Right input response 前後左右飛行動作反應偏快	Roll rate too high 滾轉速率偏快	Adjust 150 MRS roll rate dial counter. 逆時針調整 150 MRS 滾轉速率按鈕

If above solution does not resolve your issues, please check with experienced pilots or contact your Align dealer.

※在完成以上調整後，仍然無法改善情況時，應立即停止飛行並向有經驗的飛行師諮詢或連絡您的經銷商。

ALIGN

Specifications & Equipment/規格配備:

Length/機身長:255mm

Height/機身高:80mm

Main Blade Length/主旋翼長:120mm

Main Rotor Diameter/主旋翼直徑:271mm

Tail Rotor Diameter/尾旋翼直徑:41mm

Motor Pinion Gear/馬達主齒:10T

Main Drive Gear/傳動主齒:78T

Drive Gear Ratio/齒輪傳動比:1:7.8

Flying Weight(without battery)/全配重(不含電池):Approx. 53g

